



Radio Control Scale Aerobatics 2019-2022



RULES GOVERNING MODEL AVIATION COMPETITION IN THE UNITED STATES

Amendment Listing

Amendment Topic	Publication Date	Description
Original Issue	1/1/2015	Publication of Competition Regulations
Model Aircraft Specifications	1/1/2015	4.3 addresses electronic stabilization
Pilot control of the aircraft	1/1/2015	10.3 Pilot control of the aircraft
General Criteria	1/1/2015	8.2.1 General Criteria
Round Corners	1/1/2015	8.2.2a Round Corners
Corner Angles	1/1/2015	8.2.2b Corner Angles
“shall” replacing “should” in several instances	1/1/2017	RCSA17091 Supporting attachment
Clarification of rule 6.2	1/1/2017	6.2 Beginning and ending a figure
Ling length criteria	1/1/2017	Family 7.8.1 – 7.8.8 Horizontal Eights
Use of another airplane	1/1/2017	10.1.3 alternate IMAC legal airplanes
Penalty Change	1/1/2017	10.1.1 Official Flight

Penalty Change	1/1/2017	10.2.1 Official Flight Unknown
Penalty Change	1/1/2017	13.1 Prior to entering
Freestyle	1/1/2019	Part 1, Section 17
Procedure to resume scored flight	1/1/2019	Section 10
Clarifies Snap Rolls	1/1/2019	Section 8.9.3, Family 9.9
Clarifies Legal Positioning and Turn-Around Figures	1/1/2019	Section 13.5
Clarifies Zeros	1/1/2019	Section 6.3
Loops and Eights	1/1/2019	Section 8.7, paragraph 8.7.1
Changes to support Electric flight	1/1/2019	Section 11

Table of Contents

SECTION I: GENERAL PRINCIPLES.....	1
1. Objective	1
2. General	1
3. Open Events.....	1
4. Model Aircraft Specifications	2
5. Scale Aerobatic Sound Limits.....	2
6. Proof of Scale.....	3
7. Material and Workmanship.....	4
8. Competition Classes.....	4
9. Classification—Contestant, Season, Advancement.....	5
10. Official Flights.....	6
11. Number of Flights.	8
12. Aerobatic Airspace.	8
13. Time Limits.....	8
14. Point System.....	10
15. Determining Placement.....	10
16. Flight Pattern.....	11
17. Four (4) Minute Freestyle Program.....	13
SECTION II: SCALE AEROBATICS OFFICIAL FLYING AND JUDGING GUIDE.....	14
1. Preface.....	14
2. FAI ARESTI System (Condensed).....	16
3. Rules.....	17
4. Aerobatic Airspace.....	17
5. Flight Path, Aircraft Attitude, and Wind Correction.....	19

6. *Grading of Figures*.....22

8. *FAI “ARESTI Aerobatic Catalogue (Condensed)” Families* 31

Section III: Glossary and Definitions60

SECTION I: GENERAL PRINCIPLES

1. Objective

Inspired by full-scale aerobatics, we strive to fly scale aerobatic model aircraft in a competitive and realistic manner that is challenging for the contestants as well as interesting for spectators.

2. General

All AMA regulations and FCC regulations covering the RC flier, airplane and equipment, shall be applicable to this event.

2.1.

Consideration of safety for spectators, contest personnel, and other contestants is of the utmost importance in this event. Any unsportsmanlike conduct or hazardous flying over a controlled spectator area will be cause for immediate disqualification of that flight. Further infractions will result in the removal of that pilot from the contest.

3. Open Events

3.1.

The events accommodate aerobatic monoplanes and biplanes which are replicas of types known to have competed in International Aerobatic Club (IAC) competition, or replicas of types known to be capable of aerobatic competition within the airspace known as the “Box.”

3.2.

All classes except Basic require that the pilot must meet the requirements defined in Rule 3.1. The Basic Class is open to all competitors with a monoplane or biplane aircraft. There is no minimum size requirement for any class. Contest Directors may make an exception for a model of a full scale aircraft that was built for IAC competition, but has not yet competed. Proof of the latter is the responsibility of the contestant.

3.3.

The known sequences will be developed, annually, by the IMAC Sequence Committee, in accordance with the current FAI “ARESTI Aerobatic Catalogue.” The IMAC Board of Directors must approve all known sequences for use in IMAC competition.

3.4.

The unknown sequences will be drawn from the catalog of Legal Unknown Figures for each class. The catalog of legal Unknown Figures is located on the ARESTI website.

3.5.

Difficulty of “K” factors for known and unknown sequences will be derived from the current FAI “ARESTI Aerobatic Catalogue.”

4. Model Aircraft Specifications

4.1.

Only one (1) propeller per aircraft shall be allowed. Internal combustion reciprocating engines and electric motors shall be allowed. If the aircraft is utilizing an internal combustion engine, only one (1) engine shall be allowed. If the aircraft is utilizing electric motors, more than one (1) electric motor may be used.

4.2.

The model shall comply with all AMA Safety Codes.

4.3.

There shall be no airborne devices fitted to the aircraft which place the aircraft under less than total control by the pilot. These devices will include, but are not limited to, gyros, automatic pilots, electronic stabilization, and timing devices. Non-airborne aids such as transmitter based functions are permissible.

Pilots found to be using prohibited devices will be disqualified from the contest.

4.4.

The Builder-of-the-Model (BOM) rule shall not apply.

5. Scale Aerobatic Sound Limits

(Figure 1 Intentionally Removed From the F&JG)

5.1. In-Flight Judging Criteria. Known and Unknown Sequences.

Judges will evaluate each individual sequence flown in its entirety for overall sound presentation. Each judged Known and Unknown sequence, shall have one “figure” added to the end of the score sheet after

individually judged maneuvers. This figure shall be known as the Sound Score. The Sound Score will have a K value dependent on the class flown.

Individual class K values are:

- Unlimited 15 K
- Advanced 12K
- Intermediate 9K
- Sportsman 6K
- Basic 3K

The sound presentation will be scored on a scale of 10 to 0 with 10 denoting “Very Quiet,” and 0 denoting “Very noisy.” Whole points will be used for scoring. This sound score will then be multiplied by the K value for the individual class and included in the total flight score for the sequence. Note that each judge’s score is independent of the other(s) and no conferencing on the sound score is required.

If a pilot receives a sound score of three (3) or less for the same sequence from two or more judges, the pilot will be notified of the problem and will be requested by the Contest Director to adjust or modify the aircraft in order to reduce the sound level prior to the next round. If that pilot, after notification, again receives a sound score of three (3) or less for the same sequence from two or more judges, that pilot will be disqualified from further competition at that contest.

6. Proof of Scale

6.1.

To prove that the model resembles a particular aircraft some proof of scale is required.

6.2.

Proof of scale is the responsibility of the contestant.

6.3.

The general outlines of the model shall approximate the full size outlines of the subject aircraft. Exact scale is not required. The model shall be judged for likeness at a distance of approximately 10 feet.

6.4.

If the contestant presents no proof of scale material with the model, and the CD can determine that the aircraft is a replica of a full-size aircraft, then the contestant will be allowed to have his/her entry considered.

6.5.

Scale shall be determined by the wingspan. A change in wingspan will become a change in overall Scale. Fuselage width, height and aircraft planform or any other variations shall not exceed 10% of scale, with the exception of airfoils and size/shape of control surface within the scale outline rule.

6.6.

A realistic three-dimensional human pilot and viewable instrument panel shall be appropriately installed in all Scale Aerobatic aircraft. (A one [1%] flight score penalty will be assessed for noncompliance.)

7. Material and Workmanship

Workmanship must be of satisfactory standards. The Contest Directors are empowered to refuse permission to fly, or to disqualify any aircraft which, in their opinion, is not up to reasonably safe standards in materials, workmanship, or radio installation.

8. Competition Classes

8.1.

The event shall be divided into five (5) classes, in order of increasing difficulty. The classes are Basic (411), Sportsman (412), Intermediate (415), Advanced (413), and Unlimited (414).

8.2.

An Optional Four (4) Minute Freestyle may also be offered. A pilot must compete in one of the above classes to be eligible for the freestyle event.

8.3.

Contest Directors and/or the sponsors of a sanctioned meet shall determine which of the classes and events will be flown. Such information must accompany all advance notices pertaining to the contest, including any planned deviation from standard rules, at least 30 days prior to the date of the contest.

9. Classification—Contestant, Season, Advancement

9.1.

A contestant may enter any one competition class at their own option. Once having flown a contest in a class, a contestant may not compete in a lower class without written permission from their regional director.

9.2.

In the USA the new contest season begins on January 1 of each year. On or before that time, the new Known sequences for all classes will be approved by the IMAC Board of Directors and made available to the IMAC membership on the IMAC website.

9.3.

A contestant in Basic through Advanced classes will be required to move to the next higher class at the beginning of the next calendar year if the contestant wins five (5) or more contests in the current year provided that in each winning contest the contestant flew against at least four (4) other competitors who made official flights. If any of the contestant's winning contests had fewer than four (4) other competitors that made official flights, that contest will not be counted in the total of winning contests used to force advancement in class.

10. Official Flights

10.1: Official flight for known program.

10.1.1.

Contestants shall have one attempt per sequence to complete the sequence. An attempt begins when the pilot or caller makes a vocal declaration such as "In the box," "Entering," or a similar statement indicating when the pilot is starting the sequence. A vocal signal is mandatory to initiate the attempt. If a vocal declaration is not made, the pilot will zero the sequence that is flown for which no vocal signal was made. Once the attempt is made by means of the vocal declaration, judging will begin as soon as the aircraft departs from the wings-level horizontal entry line and enters the first maneuver of the sequence. The horizontal entry line to the first maneuver of a sequence is not judged.

10.1.2.

If a Known sequence in progress cannot be completed due to mechanical problems with the aircraft (including but not limited to engine failure, radio malfunction, etc...) the contestant will receive zeros for each un-scored maneuver in that sequence. If the second sequence is yet to be flown and the aircraft cannot be made ready to safely fly, the contestant may attempt the second sequence with an alternate IMAC legal airplane (as defined in sections 4, 6, and 7 above). In such cases, the contestant will be positioned last in the round and be subject to whatever time constraints may be in force at the contest. When the contestant is again airborne they will fly the second sequence. In this case, no penalty will be imposed for repositioning to the end of the round rotation.

10.1.3.

If a sequence cannot be completed the contestants will receive a zero (0) for each un-scored maneuver in that sequence unless the interruption was beyond the control of the pilot (avoidance, mid-air collision, directed by the CD, Line Boss, or Judges).

10.1.4.

An official flight (round) is two (2) sequences and the contestant is expected to be able to fly both sequences without refueling between sequences. If the second sequence cannot be completed the contestants will receive zero (0) for each un-scored maneuver in that sequence. The only exception is if Rule 10.1.2 is in effect.

10.2: Official flight for unknown program.

10.2.1.

Contestants shall have one attempt to complete the sequence. An attempt begins when the pilot or caller makes a vocal declaration such as "In the box," "Entering," or a similar statement indicating when the pilot is starting the sequence. A vocal signal is mandatory to initiate the attempt. If a vocal declaration is not made the pilot will zero the sequence that is flown for which no vocal signal was made. Once the attempt is made by means of the vocal declaration, judging will begin as soon as the aircraft departs from the wings level horizontal entry line and enters the first maneuver of the sequence. The horizontal entry line to the first maneuver of a sequence is not judged.

10.2.2.

If an unknown sequence in progress cannot be completed due to mechanical problems with the aircraft (including but not limited to, engine failure, low fuel, radio malfunctions, etc.), the contestant will receive zeros (0) for each un-scored maneuver in that sequence.

10.3: Resumption of scored flight

10.3.1

If a sequence in progress is determined by the judges to have been interrupted by a circumstance beyond the control of the contestant, or following a break in sequence (Section II, 6.3.d), the contestant will resume the sequence with the last scored figure (figure prior to the interruption, or the figure in progress (zeroed) when the break in sequence occurred). This figure will not be judged. The pilot will establish a wings level entry line; the pilot or caller will make a vocal declaration, and then perform the prior figure. Judging will resume after completion of said prior figure.

10.3.2

Note that a midair collision is considered to be "beyond the control of the contestant." If a mid-air occurs, each pilot, if still flying, must land and pass a safety inspection by the CD before continuing. The pilot has the option of continuing with a different plane. After the mid-air, each pilot involved will declare his/her intention to complete the round or not. If the contestant chooses to continue, they will be positioned last in the round and be subject to whatever time constraints may be in force at the contest. In this case, no penalty will be imposed for repositioning to the end of the round rotation. When the contestant is again airborne they will resume the round with the figure prior to that in which the

interruption occurred. This figure will not be judged. Judging will resume after the completion of said prior figure. If the contestant chooses not to continue the round, they will receive zeros for all maneuvers not yet scored at the time of the mid-air.

10.4: Pilot control of the aircraft.

Once the pilot announces an attempt until the pilot completes the sequence, (known, unknown, or freestyle) only the pilot may operate the transmitter which is controlling the aircraft. Any assistance of any kind provided by another person to operate the transmitter (e.g., changing switches, programming modes, etc.) will result in the pilot receiving a zero for the sequence or Freestyle in progress when the assistance was provided. This rule applies only from entering the sequence until the sequence is complete. This rule does not apply to takeoff, landing, or flight between sequences.

11. Number of Flights.

An official flight (round) for the known program is defined as a minimum of one (1) sequence, and not more than two (2) sequences, as published by the CD in the contest announcement. The CD may also use a single sequence rounds if time constraints prevent completion of a planned two (2) sequence round. When an official known flight (round) is two (2) sequences, the contestant is to be able to complete the round without refueling between sequences. If the second sequence cannot be completed the contestant will receive a zero (0) for each un-scored maneuver in that sequence.

An official flight (round) for the unknown program is defined as one (1) sequence.

There shall be no limit on the number of flights (other than that imposed by time available).

12. Aerobatic Airspace.

Refer to Section II, Paragraph 4.

13. Time Limits.

13.1.

The contestant has two (2) minutes to start his/her engine and become airborne. If after two (2) minutes the contestant is unable to start the engine, they will move to the end of the round rotation. If the contestant fails to start a second time, they shall receive zero for the round.

13.2.

The contestant has one (1) minute from the time the wheels leave the ground during takeoff to enter the aerobatic airspace.

13.3.

There shall be no time limit while in the aerobatic airspace.

13.4.

The contestant has two (2) minutes between leaving the aerobatic airspace and touchdown for landing, unless required to hold upon command from the appropriate official.

13.5.

Prior to entering the aerobatic airspace, between sequences, and prior to landing, pilots shall be allowed to perform only the following trim and positioning maneuvers:

- Turns.
- Half Cubans or Reverse Half Cubans with only a single ½ roll on the 45 degree line. Note: The 1/2 roll is optional based on the aircraft orientation required to initiate the aerobatic sequence.
- Single 1/2 roll to inverted immediately prior to an attempt when the first figure requires an inverted entry.
- Single 1/2 roll to upright following an inverted exit from the last maneuver.
- Half Loops:

1) Half inside loop with only a single ½ roll on entry or exit. Note: The 1/2 roll is optional based on the aircraft orientation required to initiate or exit the aerobatic sequence.

2) Half outside loop to upright for sequences that end in inverted flight.

Note: For sequences that start inverted, once inverted the pilot is committed to the attempt and must initiate the sequence. Unless specifically noted, all turn-around figures must initiate from upright flight, and aircraft must be returned to upright flight upon completion of the first sequence.

Exceptions to allowable turnaround figures may only be directed by the CD or line boss in the course of managing the airspace. Pilots will follow such directions and no penalty will apply.

Turnaround maneuvers may not be performed at low altitude or directly in front of the judges. No other aerobatic maneuvers are allowed immediately following the airplane breaking ground.

An illegal maneuver performed before entering a sequence will result in zeroing the following sequence. An illegal maneuver prior to landing will result in zeroing the preceding sequence.

The Four Minute Freestyle is exempted from these limitations.

The intent here is to prevent anything that may be viewed as “practice” and hence give one competitor an advantage over another. Therefore, snaps, spins, point rolls, or any other Aresti based aerobatics figures may never be executed after breaking ground and before entering the sequence, between sequences or after completing the sequence(s) and prior to landing.

14. Point System.

14.1.

All classes shall have the scheduled maneuvers scored on a scale of 10 to 0. Half (0.5) points may be used in judging. Points are deducted for imperfections as per the Scale Aerobatics Official Flying and Judging Guide (Section II of this document).

14.2.

Degree of difficulty factor (K-factor) values shall be assigned to individual maneuvers based upon the current FAI catalog of maneuvers, with modifications as required by the International Miniature Aerobatic Club (IMAC). When calculating contestant scores, each individual maneuver score shall be multiplied by its K-factor. The flight score shall be the result of summing the “K-factored” (maneuver score multiplied by K-factor) scores.

15. Determining Placement.

15.1: Sequence scoring.

a: Scoring.

The Official IMAC Scale Aerobatics Contest Guide shall be used to determine the number of sequences to be scored (drop schedule) and the weight of the unknown(s) based on contest category (2 day, multi-day, regional, etc.). Refer to Appendix A of the Official IMAC Scale Aerobatics Contest Guide for the drop schedule for known and unknown sequence flights.

b: Unknowns.

Each unknown sequence shall be flown once. The Official IMAC Contest Guide shall be used to determine how the known scores and unknown scores are combined based on contest category.

c: Combined Scores.

The highest combined scores will determine the winner.

d: Normalization.

All sequences will be normalized to 1,000 as outlined in Rule 15.4.

15.2.

In the case of ties, the best non-scored sequence of the contestant shall be used to determine the winner.

15.3.

The same set of judges shall judge each round. Judges may be rotated between rounds.

15.4.

Each sequence shall be normalized to a standard 1,000 points. The pilot with the highest raw score receives 1,000 points for the sequence. Each pilot thereafter shall have their raw score divided by the high raw score giving a percentage of that high raw score, which is then multiplied by 1,000 to get the normalized score. Scores shall be rounded to two (2) places of decimal accuracy. For example: Contestant A wins the sequence with a raw score of 4,850 points. Contest B is second with 4,766.5 points. Contestant A receives 1,000 points for the sequence. Contestant B's score is 982.78 points ($4,766.5 \div 4,850 = 0.982783 * 1,000$ for 982.783, which rounded to two (2) places of decimal accuracy for a final score of 982.78).

16. Flight Pattern.

16.1.

A contest shall include one (1) or more rounds of Known sequences and may include one (1) or more Unknown sequences. Any given unknown sequence can only be flown once per contest.

16.2.

Compulsory Known Maneuver Sequences are defined by rule 3.3.

16.3.

Optional Unknown Maneuver Sequences shall include separate Sportsman, Intermediate, Advanced, and Unlimited sequences, each consisting of up to 15 maneuvers.

a.

Unknowns shall be distributed the day of the contest or the night before to allow pilots to mentally fly and visualize them. If a contestant is found to have practiced the Unknowns with a flying model or on a computerized flight simulator, that contestant will be disqualified from the entire contest.

b.

Flight order for the Unknowns should be established by random drawing.

16.4.

The contestant must fly his entire flight according to the established flight schedule for his particular class and in the sequence listed. Maneuvers that are executed out of sequence, or not executed as required by the sequence, will be zeroed. Remaining maneuvers that are flown in their appropriate area and in the appropriate order following the zeroed maneuver will be scored.

16.5.

Takeoff and landing are not to be considered judged maneuvers. It is not necessary for the judges to see the aircraft take off or land. The aircraft may be carried to the takeoff point, and carried from the landing area, if so desired.

17. Four (4) Minute Freestyle Program.

17.1.

- 1.1. 17.1: The 4 minutes Freestyle program is meant to be a show, an artistic performance combining choreographed aerobatic maneuvers matching the rhythm and tone of the music in a way that evokes an emotional response from the judges and spectators. To be eligible to participate and compete in this event, the competitor must also compete in one of the five IMAC categories of precision sequence flying at the same event. It should have separate awards when offered. It is graded on the following criteria:
- 1.2. A: Use of total flight area (20K) The pilot should make full use of the available flight area, with a balanced mix of maneuvers at both ends of the flight area. Pilots that use only one side, or never leave the middle of the flight area should receive lower scores. Pilots should position maneuvers to help judges and spectators observe all aspects of the maneuver. Pilots should use a combination of fast, high-energy maneuvers with a small footprint, and long, slow maneuvers using a large footprint to demonstrate a wide range of flight skills.
- 1.3. B: Originality and Complexity (20K) Pilots should perform a wide variety of figures. Pilots that repeatedly perform a single maneuver should receive lower scores, even if that maneuver is highly complex. Judges should award the highest scores to pilots that demonstrate a wide variety of complex maneuvers. Pilots should demonstrate complexity using all the aerodynamic and gyroscopic forces available, including stalled flight, autorotation, and propeller torque.
- 1.4. C: Precision (20K) All maneuvers should demonstrate the precision expected for normal maneuvers. Roll rates should be constant for continuous rolls. Rolls should stop at the normal points (e.g., 1/8, 1/4, 1/2, full). Point rolls should have a constant rhythm. Lines should be straight, and horizontal, vertical, or 45 degrees. Arcs and turns should have constant, continuous radii. Changes in altitude during a maneuver should be consistent with the maneuver, demonstrating the pilot's ability to control the aircraft at all times.
- 1.5. D: Artistic impression and Presentation (30K) The music should establish a mood, and the movement of the airplane should match that mood. The rhythm of maneuvers should follow the music. Changes in the music should be reflected by changes in the flight.

E: Choreography (30K) Pilots should demonstrate a well-rehearsed choreography of maneuvers, not a random selection of maneuvers. Maneuvers should flow from one maneuver to the next, without long pauses between maneuvers.

17.2: Judging the Four (4) Minute Free Program.

a: Any number of judges can be utilized, but there should be a minimum of 3. Judges must be familiar with the criteria, not randomly selected spectators. A separate individual should be assigned as a timer.

b: Each criteria will be judged from ten (10) to zero (0) in 0.5 increments

c: Scored flight and timing begins when the pilot or caller signals the judges for an air start, or when the planes wheels leave the ground (ground start). Scored flight ends when the pilot announces the end of flight, the pilot lands, or time reaches 4 minutes. If scored flight ends prior to 3 minutes 30 seconds (three and one-half minutes), the score will be prorated by the fraction of the four minute flight time using the following formula:

Judges Score x (Actual Flight Time /4) If scored flight ends any time after three and one-half minutes, there is no penalty. The judges will stop scoring when the timer announces "Time" at the four minute mark.

d: The following circumstances with disqualify pilots flight:

d.1: Any part of the plane touches the ground for any reason other than takeoff or landing.

d.2: The plane crosses onto the pilot side of the Dead Line:

d.3: The pilot performs dangerous or unsafe maneuvers or high energy maneuvers directed at the judges or spectators as determined by a majority of the judges and/or the CD.

d.4: The pilot touches the plane during flight.

SECTION II: SCALE AEROBATICS OFFICIAL FLYING AND JUDGING GUIDE

The current Scale Aerobatics Contest Director's Guide is available from the International Miniature Aerobatics Club (IMAC) secretary, or may be downloaded from the IMAC website: www.mini-iac.org

1. Preface.

The purpose of this Scale Aerobatics Flying and Judging Guide is to provide an accurate description of each type of maneuver used in competition and to provide a reference for use in developing a uniformly high standard of judging in all AMA sanctioned contests. Study of this guide by the competitor will help him or her learn exactly what is expected, while study by the judges will help them decide precisely how well the competitor meets these expectations.

Flying and judging are very similar in nature; this is why contestant judging is generally promoted. Nevertheless, there are some key differences between judges and pilots, mostly related to Mental Attitude and Technical Knowledge.

Reference to any gender in this document shall include both male and female.

1.1: Mental attitude.

Mental attitude by itself can be divided into five (5) sub-categories:

1.1.1: Bias.

Bias can either be conscious or unconscious. The conscious bias is fortunately rare, and would be for instance when a judge deliberately awards a score lower or higher than the competitor deserves. The word for that action is cheating and it shall not be tolerated. Conscious bias can also occur because a friendship or regional relationship with the competitor. Most problems with bias are of the unconscious or unintentional type since they are more prevalent. A good example would be the ‘halo’ or recognition for a champion or well-known flier who might unintentionally be awarded extra points based on recognition alone. This can work against an unknown flier having a great day. This type of bias can also work against the champion flier, just because the judge unconsciously might want to see a new face in the winner’s circle. Another example might be bias towards a certain type of airplane like mono versus biplane, or bias towards a style of flying.

For instance, a pilot cuts crisp corners on square maneuvers versus a flier with a more graceful style. Sometimes we even see an equipment bias where a judge may unknowingly try to support a previous personal opinion regarding a certain brand of radio, certain type of engine, or size of aircraft. These unconscious biases are easily understood as we all have personal preferences. Nevertheless, the judge must try hard to base his or her score solely on the quality of the flight, and nothing more.

1.1.2: Self-confidence.

The self-confidence factor is based on knowledge instead of arrogance or ego. A judge with self-confidence can score a pilot fairly, whether he is a World Champion or not. A judge with self-confidence will not be uncomfortable in giving a wide range of scores in a single sequence. Scores as low as 2 or 4, or as high as 9 or 10 will not be uncommon.

1.1.3: Sense of independence.

A judge doesn’t operate in a glass cage but shares the flightline with another judge and scribes. The judge cannot allow himself or herself to be influenced by more dominant or experienced personalities sitting nearby. Judging is an independent exercise and caution should be exercised not to influence or be influenced by others on the flightline. If scribes are used, scores should be communicated using a low tone voice so that the other judge and the pilot cannot hear and be influenced by it.

1.1.4: Adherence to the rules.

Adherence to the rules is probably the most significant of all the elements required to make a good judge. A good judge has developed a sense of fair playing and knows that a good contest is one in which everyone plays by the same rules. Anyone sitting in a judging chair must adhere to the rules existing at that time or disqualify him or herself.

1.1.5: Technical knowledge.

Technical knowledge employs the use of an organized system of downgrading as well as the need to be consistent and accurate. The downgrading or deficit grading system assumes that the contestant is going to fly a perfect maneuver that starts with a 10, and then downgrades it based on the mistakes observed as they occur, rather than falling into the trap of scoring on overall impression. It should be assumed by a judge that a contestant is going to fly a well-formed maneuver, so he should start with the grade of 10. As he watches the maneuver, he then begins to find fault with what he sees and starts downgrading as it progresses. This system is preferable to waiting until the maneuver is finished, and tries to assign a grade on overall impression. The latter can be erratic and inconsistent, and also confines grading into a too narrow range. However, as a final check, the score should be consistent with the figure's overall quality.

Every judge should strive for a high degree of consistency and accuracy. The most important aspect of consistent judging is for each judge to establish his or her standard and then maintain that standard throughout the contest.

2. FAI ARESTI System (Condensed).

Scale Aerobatics sequences are based on a catalog of maneuvers adopted by the FAI (Fédération Aéronautique Internationale), from the “ARESTI Aerobatic Catalogue (Condensed)” for full-scale aircraft aerobatics. The catalog consists of the following nine (9) families of figures:

- i.: Family 1—Lines and Angles
- ii.: Family 2—Turns and Rolling Turns
- iii.: Family 3—Combinations of Lines
- iv.: Family 4—(Not in Use)
- v.: Family 5—Stall Turns
- vi.: Family 6—Tail Slides

vii.: Family 7—Loops and Eights

viii.: Family 8—Combinations of lines, Angles, and Loops

ix.: Family 9—Rolls and Spins

It is beyond the scope of this Flying and Judging Guide to explain in detail the structure of the ARESTI catalog, and how to read the ARESTI drawing language used. A good judge (as well as a pilot) must become very familiar with the above and should be able to quickly understand the maneuver simply by looking at the ARESTI drawing. The complete catalog of figures is available directly from the ARESTI Web site at (<http://www.arestisystem.com>). Judges and pilots are strongly encouraged to download this document for personal reference.

3. Rules.

Scale Aerobatics has several rules that differ from either full-scale Aerobatics (IAC) or AMA RC Aerobatics (AMA Pattern). Because the judging pool used in Scale Aerobatics contests sometimes comes from both or either of those two groups, it is useful to go through the major differences:

Rules	Scale Aerobatics	IAC	Pattern
Downgrade one (1) point for each deviation of:	10 degrees (½ point for 5°)	5 degrees	15 degrees
Judging criteria:	Flight path	Aircraft attitude	Flight path
Number of judges	2 minimum	5 standard 3 minimum	2 minimum

4. Aerobatic Airspace.

4.1: X-Axis and Y-Axis.

The X-Axis is the main axis of flight, parallel to the flight line. The Y-Axis is perpendicular to the X-Axis (flight line).

4.2: Deadline.

The “Deadline” is located 100 feet (30.5 meters) in front of the contestant. This line delimits the “no-fly” zone for safety reasons and the aircraft must at all times remain on the side of the deadline away from the contestant, pits and spectators. The judges shall zero (0) any maneuver where the aircraft completely or partially crosses the deadline. For repeated deadline violations by a contestant during a flight, the CD may ground the flight in progress and zero the round. If a contestant repeatedly violates the deadline, the CD may disqualify the contestant from further competition at the event.

If there is no natural barrier or demarcation at or beyond 100' that can be used to clearly mark the deadline, the CD must set up clearly visible markers at the deadline distance for the judges to use in enforcing deadline observance.

4.3: Airspace Control Score.

Judges will evaluate each individual sequence flown, in its entirety, for overall airspace control. Each judged Known and Unknown sequence, shall have one “figure” added to the end of the score sheet, after individually judged maneuvers. This figure shall be known as the Airspace Control Score and will be assigned by each judge.

The Airspace Control Score will have a K value dependent on the class flown. This score will then be multiplied by the K Value for the individual class.

The following standard will be used for assessing the pilot’s performance in maintaining control and awareness of the aerobatic airspace and placing figures in the airspace in a manner that allow the figures to be optimally judged.

The highest standard for Airspace Control will be the pilot that exhibits a significant ability to control the location of the aircraft inside the airspace, relative to the judges, which results in a tight footprint and has the aircraft such that it can be optimally judged at all times. The pilot that exhibits excellent airspace control should receive a ten (10).

The lowest standard for Airspace Control will be the pilot that exhibits a poor ability to control the location of the aircraft inside the airspace, relative to the judges, which results in an excessively large footprint and has the aircraft consistently so far away as to be difficult to properly judge. The pilot that exhibits very poor airspace control should receive a zero (0). Pilots exhibiting airspace control within the range of these two standards will be graded with a range of possible scores from ten (10) to zero (0) in whole point increments.

The K factors for the Airspace Control Score are:

- Basic = 3K
- Sportsman = 6K
- Intermediate = 9K
- Advanced = 12K
- Unlimited = 15K

5. Flight Path, Aircraft Attitude, and Wind Correction.

Scale Aerobatics requires all maneuvers within the sequence to be wind corrected. See Rule 5.3.

Judges should evaluate any maneuver focusing primarily on the aircraft flight path, but at the same time, also downgrade for any variation of the aircraft attitude that is not directly related to maintaining a correct flight path.

5.1: Flight path.

Think of the aircraft condensed into a single dot and watch the path this dot takes through the sky. This is the flight path, or track, or the aircraft's center of gravity. Judging the flight path consists of comparing the observed path with fixed references such as the horizon, or the X and Y-axis of the aerobatic airspace.

5.2: Attitude.

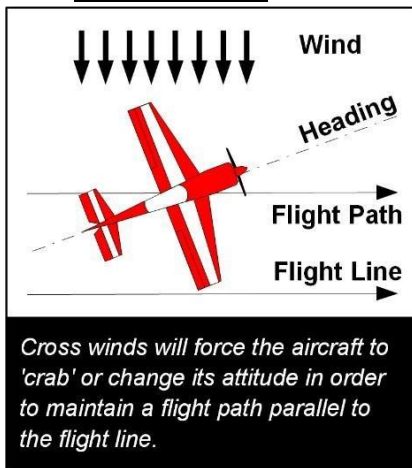

The aircraft attitude is defined as the position of the aircraft in the sky, and is characterized by the variations it has on the yaw, pitch, and roll axis. In a "no-wind" and normal speed condition, the aircraft's attitude (its heading) will generally point in the same direction as the flight path. In case of a cross wind, the aircraft attitude must vary (on the yaw axis) in order to maintain a constant and straight flight path, as required by the Scale Aerobatics rules (Fig. 2).

Figure 2

Also, a reduction in speed will force the aircraft to change its pitch in order to maintain the correct flight path (Fig. 3).

Depending the type of aircraft (low wing, high wing, etc.), the flight attitude might be different from one to another to maintain the correct flight path. Judges shall disregard this difference in attitude and only concentrate on the flight path described by the aircraft.

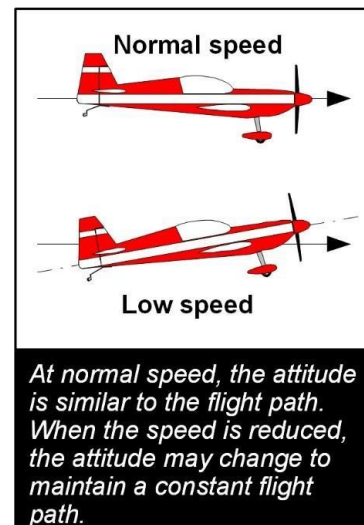

Figure 3

5.3. Wind correction.

When judging a maneuver, understanding what constitutes wind correction, and what is not, is one of the toughest challenges. The general rule is that judges shall ignore any aircraft change of attitude required to maintain a correct flight path. At the same time, the usual 0.5 point deduction per 5 degrees of deviation shall be applied to anything that is not related with wind correcting. For instance, when the wind is blowing parallel to the flight path, the pilot flying a vertical line might use its elevator to change the aircraft's attitude in order to maintain a straight vertical flight path (Fig. 4).

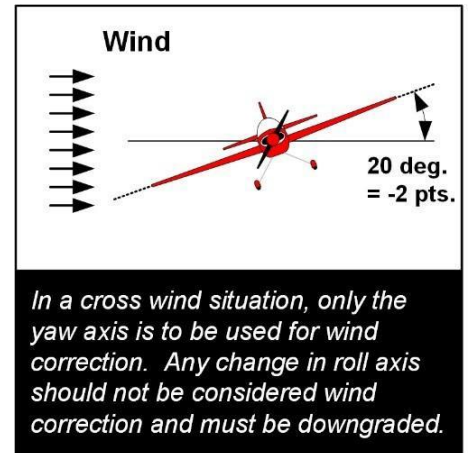

Figure 4

This change of attitude shall not be downgraded.

On the other hand, any bank angle of the wing in the roll axis should be

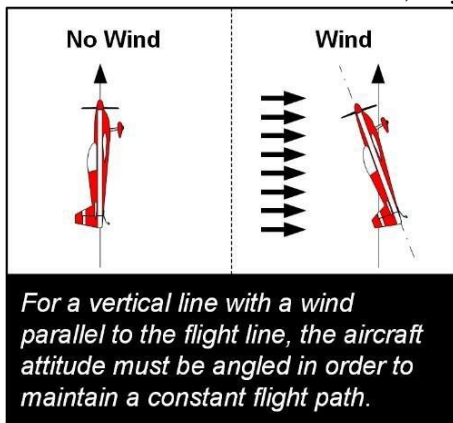

Figure 5

downgraded using the standard rule of 0.5 point deduction per 5 degrees (Fig. 5). The judges shall only downgrade for induced pilot corrections and disregard any sudden attitude changes due to wind bumps. Always give the competitor the benefit of the doubt when not sure.

The only maneuvers that are not to be wind corrected are the ones involving a stalled condition, such as a Stall Turn (otherwise known as “Hammerhead”), Tail Slide, spin and snap roll(s) (otherwise known as a “flick roll”). During the period of time that the aircraft is in a stalled,

or near stalled condition, any wind drift shall be disregarded by the judges and not downgraded.

Wind correction shall be used throughout the aerobatic airspace. Any drift observed on any line (horizontal, 45 degrees or vertical) shall be downgraded using the 0.5 point deduction per 5 degrees rule (Fig. 6).

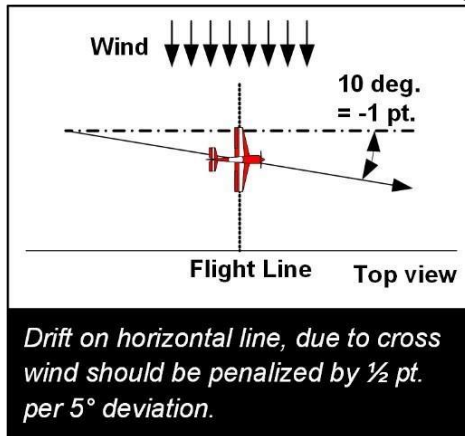

Figure 6

For instance, in the case of a Stall Turn performed with a severe crosswind, the vertical line will start directly after the 1/4 loop. This is the first point of reference to be used for the upline. The flight path on the way up is 15 degrees off compared to the perfect vertical up line; the downgrade should then be 1.5

points.

When the aircraft starts its Stall Turn, it is in a stalled condition and no downgrade shall be applied for wind drift during that time. Once the rotation is complete, a new reference point shall be established for the perfect vertical downline. If the flight path on the downline is 20 degrees off, the downgrade should then be 2 points (Fig. 7).

The competitor is required to make the shape of all maneuvers perfect regardless of the wind conditions. Loops and partial loops must be round, vertical lines must be perpendicular to the horizon and horizontal line parallel to the X or Y-axis. For 45-degree lines, judges must make an allowance for the aircraft's position relative to their own.

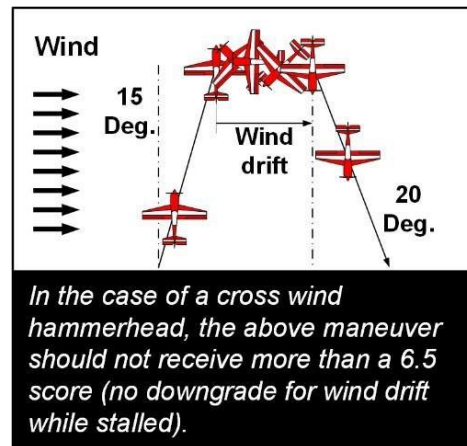

Figure 7

A true 45 degree line flown at the end of the aerobatic airspace will appear steeper when flown towards the end of the airspace and shallow when flown towards the center. Judging is of the true line flown and judges should not downgrade the maneuver for visual deformation due to the angle it is observed. Always give the competitor the benefit of the doubt when not sure.

6. Grading of Figures.

The judges will independently assess the quality of each figure and its components as performed in the sequences, grading with numbers from ten (10) to zero (0) in increments of one-half (0.5) point. A grade of ten (10) represents a perfect figure in which the judge saw no deviations from prescribed criteria.

Remember, it is the judge's job to find fault: be a nitpicker. On the other hand, give a grade of 10 if you see a perfect figure—but if you are really being critical, you won't see too many. Don't get in a rut. Guard against confining your grades in too narrow a range. If you watch carefully and grade consistently, you will find yourself giving an occasional 2, 3, or 4 on some sloppy figures that are not quite bad enough for a zero. You will also be giving an occasional 9 or 10 for the superlative figure which you can find little or no fault.

As a judge, you are expected to grade only against one standard, and that is perfection. The performance of the aircraft, the difficulty in performing a figure (on the basis of your personal experience or perception), the weather condition or the pilot's name and reputation should not be considered in formulating your grade.

Two (2) judges should be used to judge each sequence. There should be enough judges available to establish a rotational procedure that will average out variations in judging. Sets of judges shall judge all contestants an equal number of times and all contestants shall have an equal opportunity to fly before all judges. Substitution of judges, which precludes equal exposure by all contestants, shall be avoided. If adverse weather conditions preclude equal exposure for all contestants, the results of the sequence may be disregarded at the discretion of the Contest Director.

6.1: General principles.

When grading the quality of the performance of individual figures, judges should consider the following general principles:

- a.*
The geometry of the figures (including the shape, radii, angles, flight path, direction of flight, heading and bank angle) must comply with the prescribed criteria.
- b.*
The precision of the performance compared to the criteria as explained later in this guide.
- c.*
The smoothness of the performance.

d.

The distinctly recognizable start and finish of each figure with a horizontal line.

e.

The figure must be the one depicted on the flimsy (Form B or C) appropriate to the direction of the flight chosen by the pilot to perform and flown in its proper order within the sequence. For figures with a Y-axis component, it is the pilot's discretion, in addition to fly inbound or out bound, as to which direction to fly the turn, left or right. For Family 9, Rotational Elements it is the pilot's discretions to which direction to perform the roll or first roll, if it is unlinked roll combination. In all cases, the figure flown must have the entry and exit direction as depicted on the flimsy appropriate to the direction of flight chosen by the pilot to perform (Form B or C) in the X-axis.

f.

The grading criteria of each component will apply in a combination figure so that one overall grade for the figure will result.

g.

The length of the lines and the size of the radii caused by the flying characteristics of an aircraft are not to be taken into account in the grading.

h.

Negative figures are graded by the same criteria as positive figures.

i.

Speed of aircraft is not a criterion. A reduction of grade will be applied for each deviation from the prescribed criteria for the figure. The grade will be reduced by 0.5 points for each 5 degrees of deviation.

6.2: Beginning and ending of a figure.

The first figure of a sequence begins at the moment the aircraft departs from its wings-level, horizontal flight path.

A figure is complete at the moment the aircraft returns to a wings-level, horizontal flight path of one fuselage plane length. The only exception to this are the exit lines in the “ARESTI Aerobatic Catalogue (Condensed)”, Families 7.4.3 and 7.4.4 (Square Loops) and 7.4.6 (Octagon Loops). Once a horizontal flight path of one fuselage plane length is established at the end of a figure, the beginning of the next figure is deemed to have occurred (Fig. 8). If an aircraft does not return to wings-level, horizontal flight at the end of one fuselage length when exiting a figure, any deviation from wings level horizontal flight to the track on the line of the following figure MUST be deducted from the score of the figure in progress using the ½ point per 5 degrees rule.

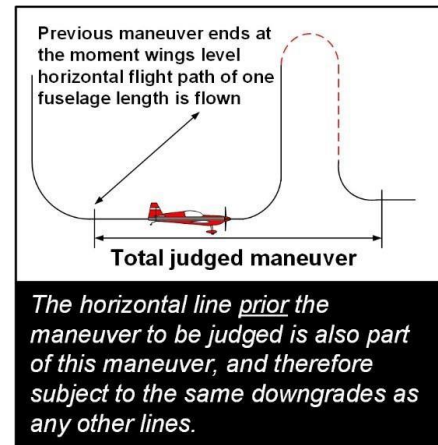

Figure 8

6.3: Zero.

A zero will be given for:

- a: Omitting a figure in the program. In this case, only the omitted figure will be zeroed. For instance, if the pilot omits the center maneuver and flies straight to do the next maneuver, only the center maneuver will receive a zero and the next maneuver will be scored normally.
- b: Flying a figure that deviates from the ARESTI drawing held by the judges for scoring purposes. For instance, if the pilot flies a Humpty Bump instead of a Stall Turn, the maneuver will be zeroed.
- c: Adding a figure to a program will zero the next following correct figure except when it is necessary to perform a Corrective Maneuver (c.1) due to the previous maneuver not being completed as per the program. A zero will be given to the figure immediately following any other added figure, even if the following figure is performed correctly.
 - c.1: A Corrective Maneuver can only be a turn of 270 degrees or less, and /or a roll of 180 degrees or less. In this case, a break penalty will be assessed against the competitor’s raw score prior to normalizing.

For instance:

1: If the exit of a maneuver is done upright instead of inverted (the pilot forgot to perform a ½ roll on the downline), and corrects this by doing ½ roll after the exit, on the horizontal line, the original maneuver will be zeroed because the ½ roll was omitted on the downline, however the following maneuver will be scored because this ½ roll was added only to correct the attitude of the aircraft for the beginning of that next maneuver (Figure 9). A

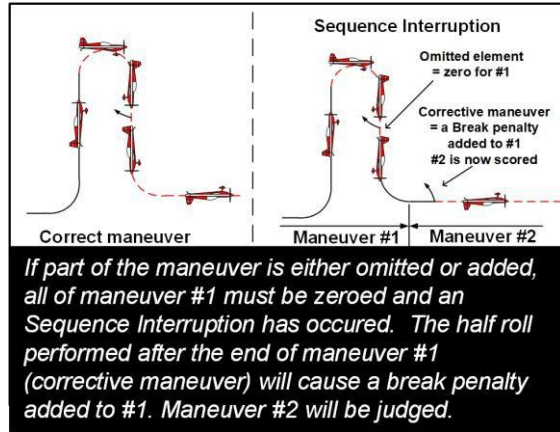

Figure 9

break penalty will be applied, see Rule 6.3.c.1.

2: If the pilot exits the maneuver in the wrong direction and/or attitude on the X-axis or the Y-axis, a sequence interruption has occurred. A zero will be assessed for the interruption. Should a “corrective maneuver” (c.1) fix the mistake and the pilot returns to the correct flight direction and attitude, judging will resume at that point and he/she will be then be assessed a break penalty, see Rule 6.3.c.1. The original maneuver will be zeroed because improper exit was performed per the ARESTI, and the following maneuver will be scored from wings level and in the correct attitude and heading.

Note: Corrective actions that exceed 270 degrees of turn and/or 180 degrees of roll constitute a Break in Sequence.

Break Penalties (deducted from raw scores prior to normalization.)	
Basic	10 pts
Sportsman	20 pts
Intermediate	40 pts
Advanced	70 pts
Unlimited	100 pts

d: Break in the sequence. A break in the sequence is characterized by a total departure from the sequence to be flown. For instance, a pilot that becomes disoriented; aborts the maneuver and circles around a couple times before resuming the sequence again.

Another example might be a pilot that aborts a maneuver thinking that the aircraft has equipment problems, makes a couple of fly-bys in order to confirm that everything is operating normal, and then decides to resume

the sequence. A deadstick, or a landing during the sequence shall not be considered as a break and all remaining maneuvers that were not flown will be zeroed.

When a Sequence Interruption occurs, the figure causing the interruption shall be zeroed and a break penalty will be assessed against the competitor's raw score prior to normalizing. Situations may occur where a pilot performs an incorrect maneuver, resulting in a zero, exits that maneuver improperly, and then performs a Break in Sequence.

In this instance, the pilot receives a zero for the first failed maneuver, a break penalty, and a zero for the next maneuver as the penalty for performing a Break in Sequence (Figure 10).⁷ Basic Components of Aerobatics.

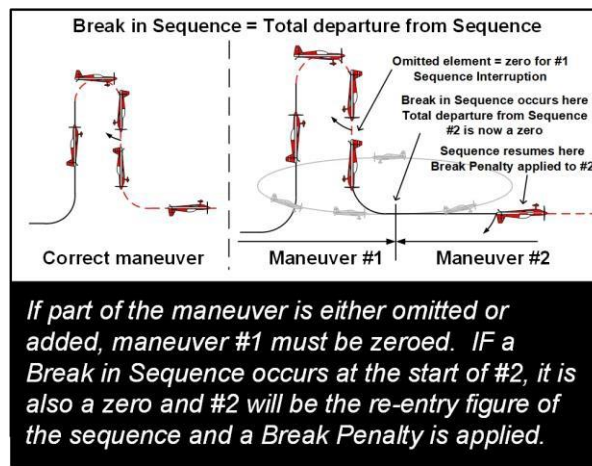

Figure 10

Resumption of scored flight: The pilot or the caller shall verbally indicate to the judges his intention to resume the sequence. He shall then first establish a wing-level horizontal line, call the restart of the sequence to get the judges' attention, perform the last flown maneuver that is to be zeroed, and continue the sequence from there on. Normal judging will resume after the completion of the zeroed maneuver.

A break in the sequence related to safety, weather, for collision avoidance, or by request from the judges or the Contest Director will not be penalized.

e: Flying a figure in the wrong direction on the X-axis. The Y-axis is non-directional.

f: Any cumulative deviation in excess of 90 degrees in the roll, pitch or yaw axes that are not related to wind corrections.

g: Any figure or figures started and flown completely or partially on the pilot side of the deadline. The aircraft must clearly penetrate the deadline to receive a zero.

Judges should score each figure independently and not communicate with each other while judging of the sequence. Once the

sequence is complete, the judges may, but are not required to, confer and review any figure receiving a zero, but need not agree on the score.

If a judge misses one or more figure, or any part of a figure, such that a grade cannot be given with full confidence, the judge should then leave the score sheet space(s) empty until the sequence is complete. He/she should then confer with the other judge and use his score for the missing figure(s). If both (or all) judges, for any reason, are not able to grade a figure with full confidence, they shall ask the pilot to re-fly the missed figure beginning with the figure prior to the missed figure. Only the missed figure will be scored in this case.

7.1: Lines.

All lines are judged in relation to the true horizon and the axes of the Aerobatic Airspace. Horizontal and Vertical lines are judged primarily on flight path (Ref Rule 5.3 for wind correction criteria).

All figures begin and end on definite horizontal lines, and both must be present in order to earn a good grade. A competitor who rushes from one figure to another, without showing this horizontal and well-recognizable line will be downgraded by one (1) point for each missing line in each figure affected.

Therefore, leaving out the line between two figures will downgrade the preceding figure by one (1) point and the following figure also by one (1) point (Fig. 11).

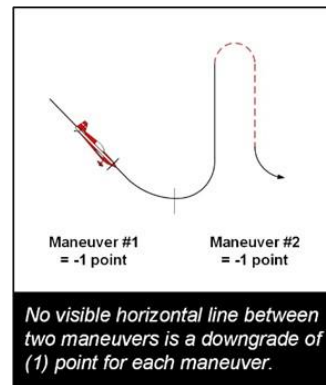
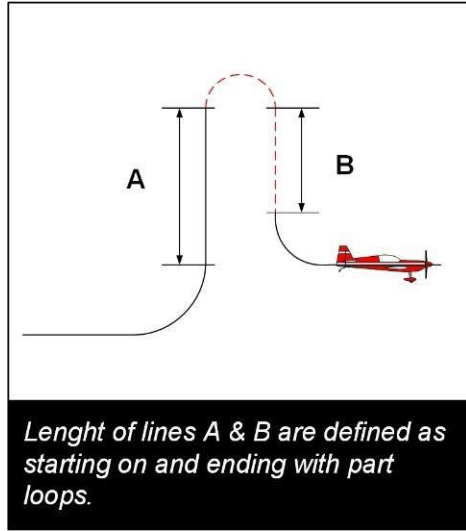

Figure 11



All lines that occur inside a figure have a beginning and an end that define their length. They are preceded and followed by part-loops. (Figure 12).

Figure 12

With the exception of Family 3 figures (Three, Four & Eight Corners) and some figures in Family 7 (Loops and Eights), the criterion for the length of lines within a figure states that they do not have to be of equal length (Fig. 12). For example, the length of the lines in a Single Humpty-bump does not need to be equal, but all four lines in a Square Loop must be of equal length (Fig. 13).

Whenever any kind of roll is placed on an interior line, the lengths of the two parts of the line before and after the roll must be equal. Exceptions are when any type of roll follows a spin element. Judges should take care to judge the symmetry of the length of lines in a figure using only the length of the lines and not

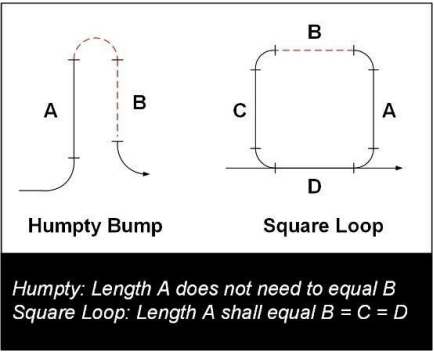

Figure 13

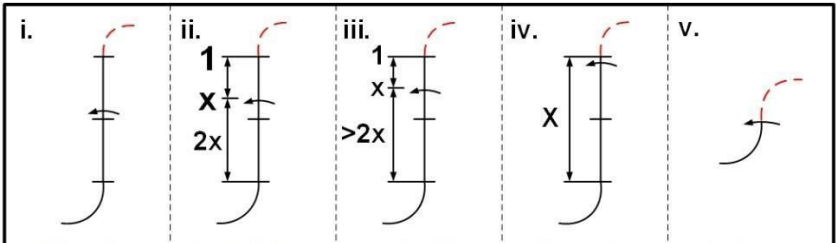

Figure 14

be elapsed time taken to fly each segment. This difference in length versus elapsed time is most noticeable in figures where rolls are placed on up-lines. As the aircraft loses airspeed, the time it takes to fly a line after the roll will be greater than the time required to fly the line of the same length before the roll.

If within a figure two or more lines must be of the same length, an observed variation is penalized by the grade in the following manner (Fig. 14):

- i. A visible variation = 1 point deduction
- ii. If the lengths vary by 1:2 = 2 point deduction
- iii. And so forth up to a 3 point deduction
- iv. No line before or after roll, 4 point deduction.
- v. No line at all before and after roll = 2 point deduction.

The basis for judging line length is the first line flown. The absence of one of these lines either before OR after a roll has to be penalized by one (1) additional point. IF there are no lines before AND after the roll, the total penalty is two (2) points only.

Example: The competitor is to fly a vertical up-line with a full roll on the line. However, the aircraft is returned to level flight immediately after the roll. The deduction is 4 points: 3 points are deducted because the lines are of vastly different length and another 1 point is deducted because of the absence of one of the lines.

7.2: Loops and part-loops.

The loop is a figure from Family 7, but part-loops are integral to every other family so it is necessary to discuss the loop before going on to the other families.

7.2.1: General Criteria.

A loop must have, by definition, a constant radius. It starts and ends in a well-defined line that, for a complete loop, will be horizontal. For a part-loop however, such lines may be in any other plane of flight. As the speed changes during execution of a loop or part-loop, the angular velocity around the aircraft's lateral axis also has to change in order to keep the radius constant. When the speed decreases, for example, to half its initial rate, the angular velocity,

to keep the same radius, will be reduced by half—this is a fact of physics. Thus, the angular velocity can be an aid for the judge to gauge the radius—especially when the angular velocity in the higher part-loop is seen to be faster, as this is a clear indication that the radius is smaller. This aid becomes more important when a line separates two part-loops. Refer to section 8.7 for specific criteria for judging loops and part loops.

7.2.2: Matching Radii.

Certain figures require that the part-loop portion of the figure have the same radius. When identical radii are required depends on the figure in question. This is defined by how a particular figure is depicted (drawn) in the ARESTI Aerobatic Catalogue.

7.2.2a: Round Corners.

For any figure having more than one internal part-loop depicted in the catalogue as an actual round, or looping line, element, all such part-loops must have the same radius – with an exception for all of Family 8.8 (Double Humpty Bumps). For those figures, the radius of the second half-loop is not required to match the radius of the first one.

7.2.2b: Corner Angles.

For any figure having more than one internal part-loop depicted in the catalogue with a hard, or corner angle, no such part-loop is required to match the radius of any other part-loop depicted in the same figure – with the exception of figures which must maintain a set geometric proportion, i.e.,

a) All of Family 3 (Combination of Lines)

b) Family 7.4.3.x to 7.4.6.x (Hesitation Loops)

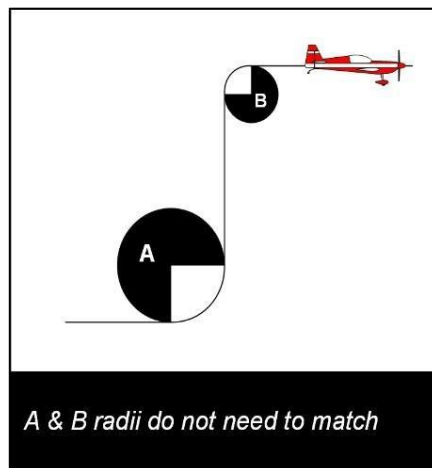

Figure 15

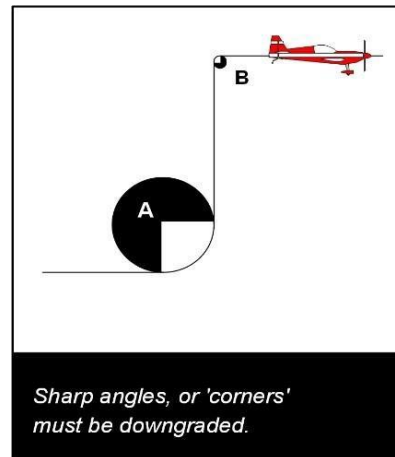

Figure 16

For example, the quarter-loop at the top of the vertical line (Family 1 figure) need not have the same size radius as the quarter-loop at the bottom (Fig. 15). However, the top radius must not be “corner” or very sharp angle (Fig. 16). It must have a smooth, distinct, and constant radius.

8. FAI “ARESTI Aerobatic Catalogue (Condensed)” Families.

8.1: Family 1: Lines and Angles.

Family 1.1.1 to 1.1.11 has been fully covered in the preceding section. Note that the figures in Family 1.2.1 to 1.2.16 are NOT performed as drawn in the “ARESTI Aerobatic Catalogue (Condensed)”. In each of these figures there are three looping components: a one-eight loop, a three-eight loop and a quarter loop. Rolls may be performed on the 45-degree line and/or the 90-degree line, with the part line being of equal length. The initial horizontal line and the line at the end of the figure may be flown at different altitudes (Fig. 17).

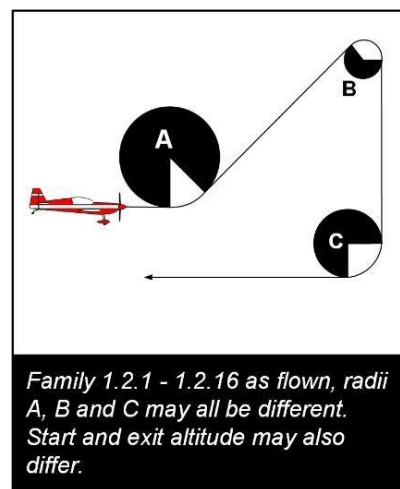

Figure 17

8.2: Family 2: Turns and Rolling Turns.

8.2.1: Turns.

In aerobatic competition, a turn is divided into three parts:

1: Establishing the bank using a roll on heading.

2: The turn itself.

3: A roll back to straight and level flight on heading.

Let's look at the turn during each of these three parts. First, the roll to establish the bank. This must be a roll of between 60 and 90 degrees; it must be performed on the entry heading; and the aircraft must maintain a constant horizontal line. Once the roll is completed and the angle of bank is established, the competitor immediately performs the turn. The turn must maintain the established angle of bank throughout. The aircraft must also maintain horizontal flight. The rate of turn is constant throughout and the maneuver must be wind corrected so that, for instance, a 360-degree turn will be a perfect circle. It should be noted that the wind correction cannot be performed by visibly changing the bank angle.

As soon as the aircraft is on the exit heading, the competitor performs another roll at a rate equal to the entry roll. Again, the aircraft must maintain a constant horizontal line.

Downgrades:

a: The angle of bank established by the initial rolling maneuver must be at least 60 degrees and not greater than 90 degrees.

Any less or more is a 0.5 point deduction for every 5 degrees.

b: The angle of bank, once established, must remain constant.

Any deviation is a 0.5 point deduction for every 5 degrees of deviation.

c: The rate of roll must be the same for the entry and exit rolls of this figure.

Any deviation is a one (1) point deduction.

d: The aircraft must maintain a constant altitude throughout the figure.

Any variation would be 0.5 point deduction for every 5 degrees of change.

e: The rate of turn must remain constant.

Any change would be not more than a one (1) point deduction for each change. Note that the rate of turn may appear to change in a strong wind, when it really isn't changing. The judges must always keep the wind in mind and give the pilot the benefit of the doubt if there is any question.

f: The aircraft must begin and end on the prescribed heading.

Any deviation is a 0.5 point deduction for every 5 degrees of deviation.

8.2.2: Rolling Turns.

The rolling turn is a figure that combines a turn of a prescribed amount with a roll or rolls integrated throughout the turn. The rolls

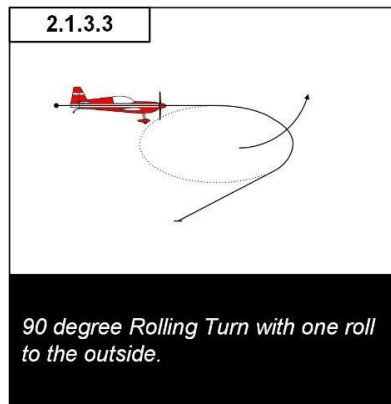

Figure 18

integrated into the turn may be in the same direction as the turn and are called “rolls to the inside” or may be in the opposite direction of the turn and are then called “rolls to the outside” (Fig. 18).

There can also be rolls alternating in and out. The direction of these rolls, to the inside or to the outside, must be flown exactly as depicted in the ARESTI. When we say that the rolls are integrated, we are saying that in addition to there being constant rate of turn throughout the figure,

there is also a constant rate of roll throughout. Naturally, the one exception to this constant roll rate is the pause when reversing roll direction. In addition, the entire maneuver is to be flown at a constant altitude.

To help visualize the execution of this figure and facilitate a way for the judges to determine a constant roll rate, let's look at an aircraft performing a 360 degree rolling turn with 4 rolls to the inside from upright (Family 2.4.7.1). First, on the prescribed entry heading, the pilot executes a turn and simultaneously initiates a roll in the same direction as the turn. The judges will expect the aircraft to be inverted at 45, 135, 225 and 315 degrees and to be upright at 90, 180, 270 and 360 degrees. At these interim headings, the judge

will NOT downgrade using the 0.5 point for 5 degree rule but will judge changes in the rate of roll, changes in the rate of turn and changes in altitude. At the end of the 4 rolls, the aircraft must have terminated its 360 degree turn and finish at the same point where it started, wings level and on the prescribed heading.

When a rolling turn is performed with rolls alternating directions, the aircraft must change direction of roll at a wings level attitude. The position of the aircraft in the turn is still only used as an aid to determine if the pilot is varying the rate of roll or turn.

Downgrades:

a: Performing more or fewer rolls than the ARESTI description calls for, or rolling in a direction different than depicted on the ARESTI results in the figure being zeroed.

b: All rolls in a rolling turn are standard rolls.

If a snap roll is performed, the figure is zeroed.

c: Each stoppage of the rate of roll is a deduction of one (1) point.

d: Each variation in the rate of roll is a one (1) point deduction.

e: Each variation in the rate of turn is a one (1) point deduction.

f: Variations in altitude are deducted using 0.5 points per every 5 degrees difference.

g: 0.5 points per every 5 degrees that the aircraft is not in level flight when reversing roll direction.

h: 0.5 points for every 5 degrees of roll remaining when the aircraft has reached its heading.

i: 0.5 points for every 5 degrees of turn remaining when the aircraft has completed its last roll.

8.3. Family 3: Combinations of Lines.

For all the figures in Family 3, (Three Corners, Four Corners, and Eight Corners) the transition from level flight to a 45 degree line shall be at a constant and reasonable one eighth (1/8) looping radius. All lines within the figure shall be equal in length. All part loops within the figure shall be of identical radii. The 45-degree transitions in Family 3 shall have a

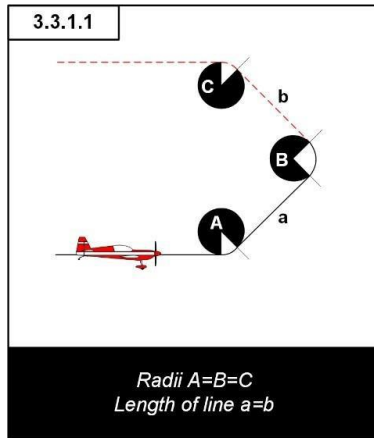

Figure 19

point deduction.

8.4: Family 4: Not in use.

8.5: Family 5.2-5.4: Stall Turns.

Stall Turns, also referred to as “Hammerheads,” are some of the most graceful figures in the “ARESTI Aerobatic Catalogue (Condensed).” In its most basic form, the figure begins when the aircraft leaves horizontal

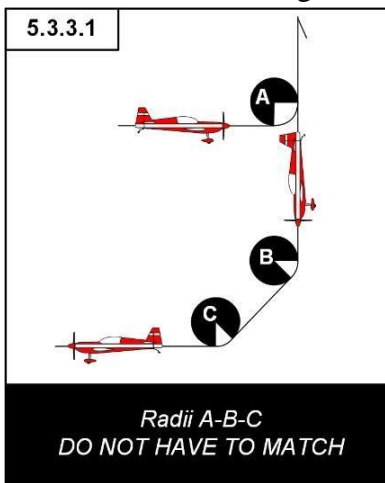

Figure 20

flight and flies a one-quarter loop to establish a vertical climb or flies a one-eighth loop to establish a 45 degree up line. If the entry is a one-eighth loop to a 45 degree line then, having presented that line, the aircraft will fly another one-eighth loop and establish a vertical up line. At the top of the vertical line, the aircraft stops, pivots and establishes a vertical descent. The vertical line may terminate in a one-quarter loop which will return the aircraft to horizontal flight and end the figure. Or, after the vertical descent from the peak, the aircraft may fly a one-eighth loop to a 45 degree down line. Having presented this line, the aircraft will fly another one-eighth loop to return to horizontal flight thus ending the figure (Fig 20).

The judging criteria are:

constant radius and not a sharp corner (Fig. 19). The basis for judging line length is the first line flown. Refer to rule 7.1 for downgrades.

The radius of all part loops in the figure are measured against the first part loop flown in the maneuver. Thereafter, each part loop flown within the maneuver that has a different radius than the first part loop flown receives a one (1) point deduction.

Each part loop flown in the maneuver must have a constant radius. Each variation of radius within a part loop receives a one (1)

a: The up and down lines, vertical or 45 degree, must be wind corrected so that they are flown as a straight line at the correct angle to the horizon.

b: On the up and down lines, any roll deviation, or deviation of the track of the aircraft in pitch or yaw will result in a deduction of 0.5 points per 5 degrees of deviation.

c: Any added roll element(s) on the vertical or 45 degree lines must be positioned so that the line segments before and after the roll elements are of equal length (Fig 21).

d: The length of the up and down lines, vertical or 45 degree, need not be equal. Therefore, the altitude of the horizontal lines at the entry and exit of the hammerhead may be different and no downgrade applies for this difference.

e: As the aircraft nears the point where it stops climbing, it must pivot in a plane parallel to vertical. Any alignment deviation from parallel to the vertical shall be downgraded 0.5 points for each 5 degrees of deviation.

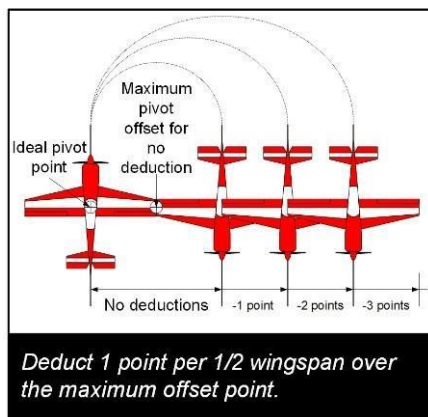

Figure 22

h: Any pendulum movement observed after the pivot is subject to downgrade at 0.5 points per 5 degrees of movement off the vertical. This downgrade is applied for each movement either side of the vertical.

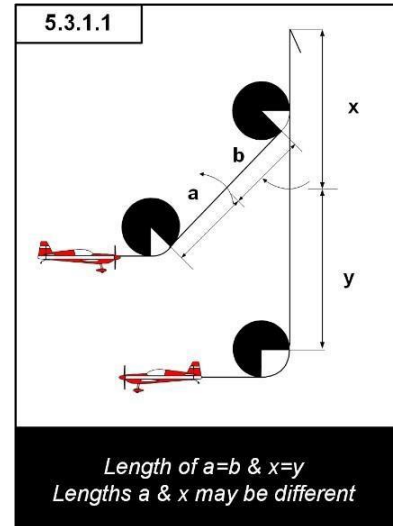

Figure 21

f: When the aircraft pivots at the top of the vertical line in a stalled or near stalled condition, no deduction shall be applied for wind drift during that particular time.

g: In the case of strong cross winds, the aircraft will most probably be “crabbing” to wind correct the up and down lines. The pivot at the top of the line might therefore be less or more than 180 degrees and no downgrade shall be applied to it.

When rotating at the top of the maneuver, ideally, the aircraft pivots around its center of gravity. To avoid a deduction, the aircraft must pivot around an axis point, which cannot be farther away from its center of gravity on the vertical up line than its wingtip ($\frac{1}{2}$ wingspans). The downgrade for this deviation is one (1) point per half wingspan that the point of rotation exceeds the maximum allowed (Fig 22).

Judges must be careful to deduct only for true extended turnaround, and not for any apparent deviation caused by wind drift during the pivot. One way to recognize a “fly-over” from a wind drift will be that the “fly-over” is generally characterized by the continuation of vertical movement and a pivot larger than 4 wingspans. A “fly-over” Stall Turn shall be zeroed (Fig 23).

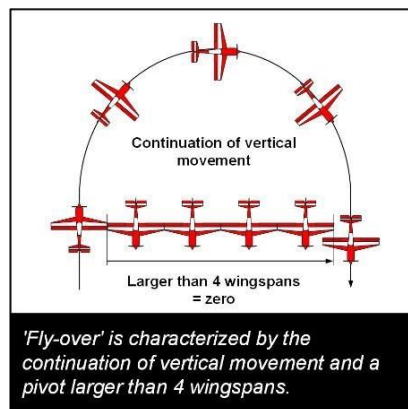

Figure 23

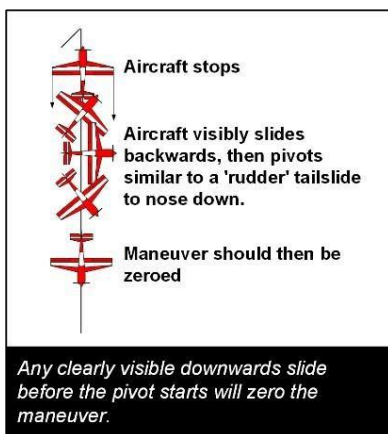

Figure 24

During the pivot, the wings must remain in the vertical geometric plane as dictated by the ARESTI. This alignment must be maintained throughout the pivot, and the aircraft’s attitude at the beginning and the ending of the pivot must be absolutely vertical. During the pivot there must be no deviation in pitch or roll. Any pitch and roll deviation observed during the pivot shall be downgraded at 0.5 points for each 5 degrees of deviation. Such movement around the roll axis during the pivot is often referred to as “torquing” (Fig 25).

The maneuver shall also be zeroed if any distinctive backward sliding movement is observed before the start of the pivot, even if the rotation is correctly performed after the slide (Fig. 24). The rate at which the aircraft pivots around its vertical axis is not a judging criterion.

During the pivot, the wings must remain in the vertical geometric plane as dictated by the ARESTI. This alignment must be maintained throughout the pivot, and the aircraft’s attitude at the beginning and the ending of the

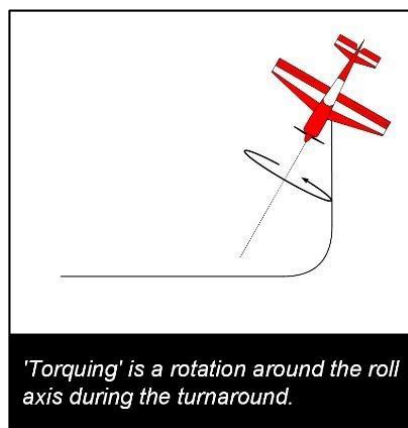

Figure 25

8.6: Family 6.2: Two Line Tail Slides.

All the criteria of the Stall Turn apply to this figure except, of course, for the maneuver at the top of the vertical climb. At the point when the aircraft stops climbing, it must slide backwards a visible amount in the vertical plane. The key here is “visible” and “vertical plane.” If the aircraft pivots directly on the top, without any clearly visible slide, the maneuver shall then be zeroed (0). Following the slide backwards, the aircraft must then tip over and fall through to a diving position. Often the nose will swing back or “pendulum” in pitch past the vertical after falling through.

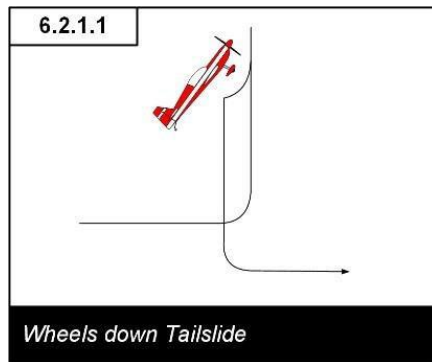

Figure 26

The figure is not to be downgraded for this, nor downgraded if it does not happen. It is a function of the length of the slide and the type of aircraft, and is not to be considered in grading the figure.

There are two types of Tail Slides: wheels-down and wheels-up. The wheels-down Tail Slide is depicted in the ARESTI diagram with a curved solid line at the top of the Tail Slide symbol (Fig. 26).

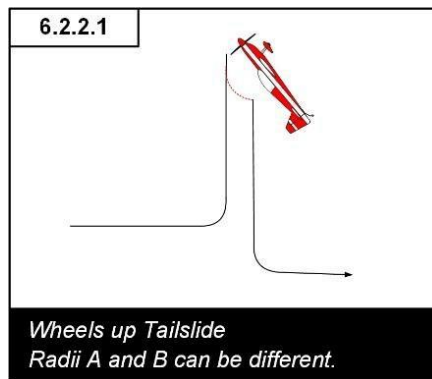

Figure 27

The wheels-up Tail Slide is depicted in the ARESTI diagram with a curved dashed line at the top of the Tail Slide symbol (Fig. 27).

This figure must be watched carefully, as the aircraft can fall the wrong way (which is graded a zero) with the correct direction of flight and the proper aircraft attitude still maintained.

The judging criteria are:

a: All lines and arcs flown in the maneuver are to be wind corrected and correctly aligned within the airspace as described in sections 5.3, 7.1 and 7.2. Observed alignment deviations receive a deduction of 0.5 points for each 5 degrees of deviation.

b: Absence of any visible backward slide in the vertical plane zero's the entire maneuver.

c: On all up and down lines, the roll attitude must be perpendicular to the plane of the main axis of flight, either the X or Y axis. This includes the duration of the fall through. Watch for the aircraft torqueing off the correct plane of flight. Any deviation in roll shall be downgraded at 0.5 points per five (5) degrees of deviation.

d: As with the Stall Turn, the aircraft will be in a stalled or near-stalled condition at the top of the vertical line and no deduction for wind drift shall be applied during that particular time..

e: The altitude of the entry and exit horizontal lines need not be the same and the figure must not be downgraded if they are different.

f: When rolls are combined with Family 6 figures, the line segments before and after the roll(s) must be of equal length. Refer to rule 7.1 for downgrades.

g: After performing the Tail Slide at the peak of the maneuver, the aircraft must establish a visible vertical down line. If this line is omitted, a downgrade of one (1) point is to be applied.

In summary, the aircraft shall make a smooth and steady transition up to vertical flight, and the aircraft shall come to a complete stop in this attitude. After sliding backward a visible amount, it shall fall through in the appropriate direction without dropping a wing or the nose moving off axis, and recover on the same plane as that of entry. After completion of this, it shall again project the 90-degree down line (wind corrected if required) before transitioning into horizontal flight with a quarter loop.

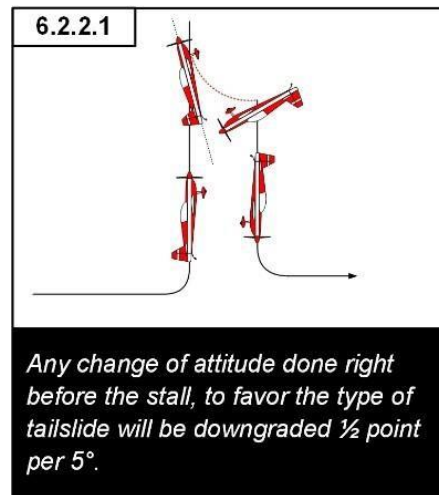

Figure 28

8.7: Family 7: Loops and Fights.

8.7.1: General Principles:

Family seven figures are covered in the following sections in groups, sections 8.7.2 to 8.7.8. Each section provides the maneuver description and the overall judging criteria for the group. Each section also provides, for the most part, the downgrades to be applied for deviations. However, some downgrades in some of the sections are not completely specified and, as such, are described here:

a. The size of a loop or part loop is not a grading criterion.

It will vary according to the flight characteristics of the aircraft. A large loop is not graded any higher or lower than a small loop, but any variation to the radius will downgrade these figures

b. All radii are to be constant. Each visible variation in the radii in a loop or part loop is to be downgraded by one (1) point. Flight path without any radius (straight line or “flat spot”), is deducted at one point per occurrence.

c. Where radii of part loops within these figures are required to be the same and they are not, a downgrade of one (1) point is to be applied for each mismatch.

The standard is the first part loop flown within the figure.

d. Where complete loops or part loops within these figures are required to be the same size and they are not, a downgrade of one (1) point per mismatch is to be applied.

e. Roll elements that are to be done on a line must be centered and are to define two equal length line segments, one either side of the roll element. Refer to rule 7.1 for downgrades.

f. Where a roll element is to be done entering or exiting a part loop there is to be no line shown between the part loop and the roll element.

The downgrade for showing a line in these situations is a minimum of two points.

g. Where a roll element is to be done on a line between two vertical half loops, or between two full loops that form a vertical eight, and the line is absent, a downgrade of two (2) points is to be applied.

There are to be no lines before or after the roll element and, if present, each such added line shall result in a two (2) point deduction.

8.7.2: Family 7.2: Half Loops.

The half-loops in this sub-family must be of a constant radius and wind-corrected to appear as a perfect half circle (see full loop discussion below). When a half-loop is preceded by a roll or rolls, the half-loop follows immediately after the roll(s) without any visible line. Drawing a line requires a downgrade of at least two (2) points depending on the length of the line drawn. Should the half-loop begin before the roll is completed, the judge must

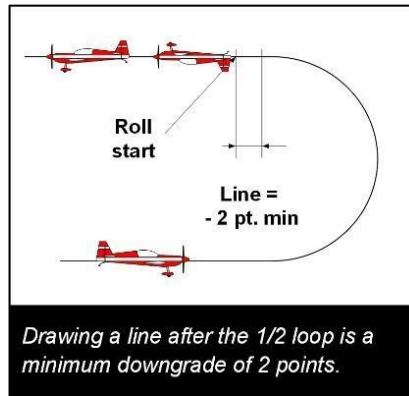

Figure 29

downgrade the figure 0.5 points for every 5 degrees of half-loop flown on which the roll was performed.

The half-loop followed by a roll is also flown with no line between the half-loop and roll. Again, drawing a line requires a downgrade of at least 2 points depending on the length of the line drawn (Fig. 29). Should the roll begin before the half-loop is completed, the judges must

downgrade the figure 0.5 points for every 5 degrees of half-loop on which the roll was performed (Fig. 30). Great care should be taken here to differentiate between aircraft airfoils and the slow speed at the top of the half loop + roll maneuver. The aircraft will appear to begin the roll before reaching horizontal flight due to its high pitch attitude. As the aircraft accelerates, it will then establish a cruise pitch attitude.

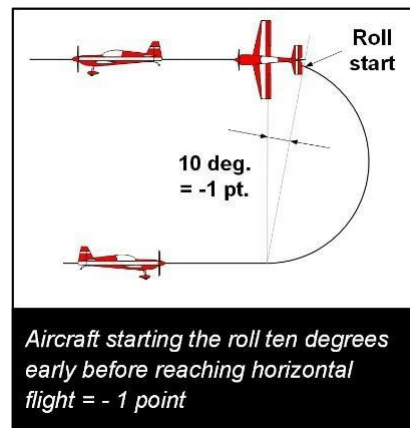

Figure 30

8.7.3: Family 7.3: Three-Quarter Loops.

Sometimes referred to as “Goldfish” (Fig 31), the entry and exit loop radii in these figures do not have to be identical. The radii of

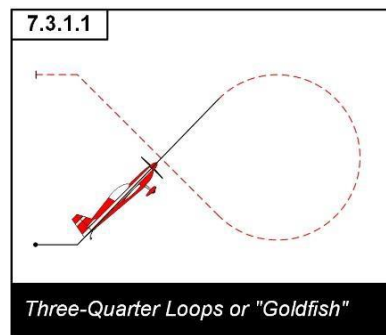

Figure 31

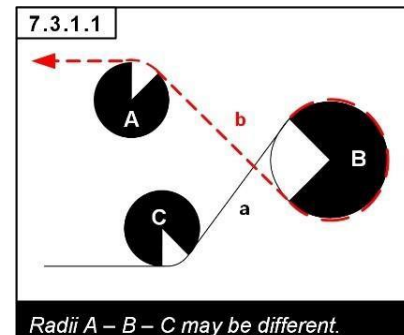

Figure 32

the three-quarter (3/4) loop is not required to match that of the entry or the exit loop radii (Fig. 32). The entry and exit lines are judged with reference to the 45 degree flight path. Any rolls on the 45 degree lines must be centered on that line. It is not required that the lengths of the 45 degree lines bear any strict relation to the diameter of the three-quarter (3/4) loop. That is, the entry and exit altitudes need not correspond to the altitude limits of the loop.

8.7.4: Family 7.4: Whole Loops.

8.7.4a: Round Loops (7.4.1-7.4.2).

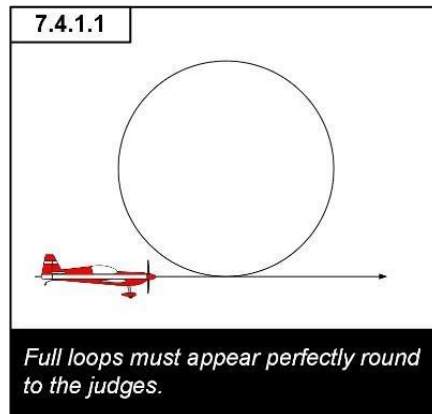

Figure 33

plane of the loop (Fig. 34). In a heavy crosswind situation, a loop might be flown with visible crabbing and no deduction shall be applied in this case.

To better quantify deductions for loops, the judges should watch for these irregularities:

perpendicular displacement, change of radius, aircraft roll and flat spots (aircraft without a flight path radius) within the loop.

Deductions are as follows:

- a. As stated in first paragraph, 0.5 points per five degrees for perpendicular displacement.

All whole round loops must appear perfectly round to the judge (Fig 33). If required, they must be wind corrected to have a constant radius. This wind correction is not only with regards to the roundness of the loop but also for the effect of any crosswind on the figure. Therefore, a standard deduction of 0.5 points per five (5) degrees shall be applied if the finish point is displaced in a direction perpendicular to the

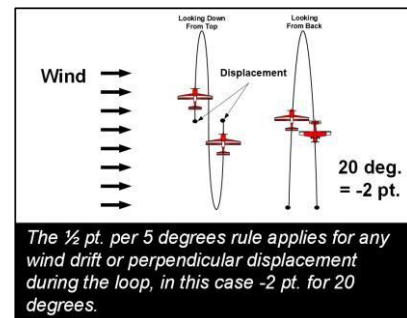

Figure 34

b. A variation in the radius will be a one point deduction per occurrence. Aircraft displaying any roll other than during a roll element on the loop, 0.5 point per five degrees of roll.

d. Flight path without any radius (straight line or “flat spot”), one point per occurrence.

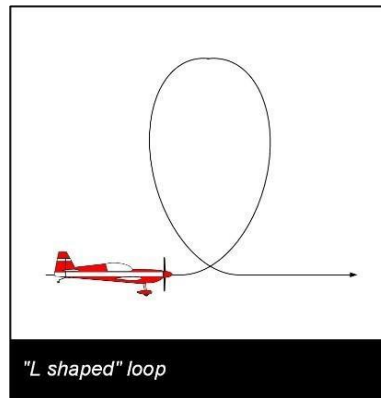

Figure 35

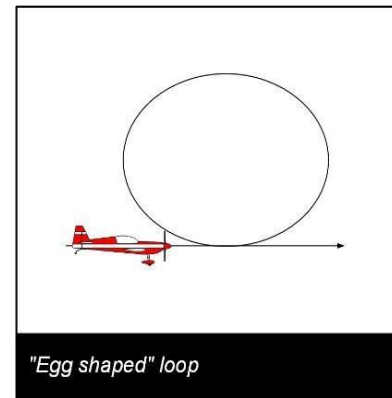

Figure 36

In judging loops, a common error is for the vertical diameter of the loop to be larger than the horizontal diameter. This is often called an “L” shaped loop (Fig. 35). Less common are loops with a horizontal diameter greater than the vertical. This is called an egg-shaped loop (Fig. 36).

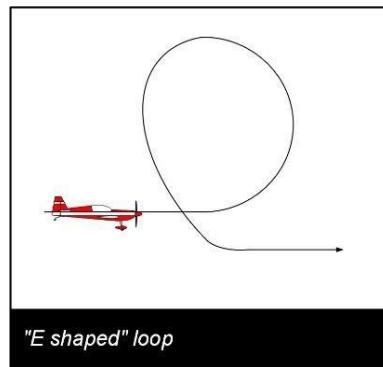

Figure 37

If there is a rolling element (roll, point rolls or snap roll) at the apex of the loop, it must be centered in the loop and flown on the arc

Another common error is in varying the radius of the final quadrant performing an “e” shaped loop (Fig. 37). The downgrades listed above shall be applied for each of these errors.

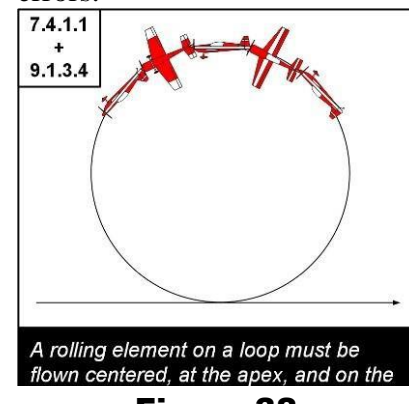

Figure 38

of the loop itself (Fig. 38). Flying the roll on a line at the apex of the loop is at least a two (2) point downgrade. If the roll is not centered, it must be downgraded 0.5 points for every five degrees that it is off center.

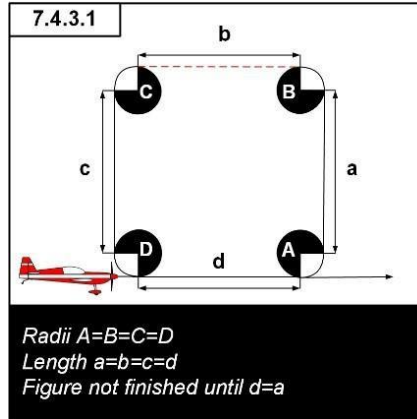

Figure 39

8.7.4b: Family 7.4.3-7.4.6: Square, Diamond, and Octagon Loops.

Square and Octagon loops are flown as hesitation loops with lines of equal length and partial loops with equal radii (Fig. 39). Square and Octagon loops are not considered complete until the last horizontal line is drawn equal to the

length of the first line of the figure.

All horizontal, vertical, and 45-degree lines are judged on flight path and shall therefore be wind corrected. As such, the judge should always expect to see these figures closed, the same way as a round loop.

Where rolls are flown on the Square or Diamond loops, they must be centered on the line. Aids for judging all hesitation loops are that a good performance will contain changes of angular velocity in all the partial loops, and variations of time taken to draw the length of each interior line, which also varies according to the aircraft's speed. The rhythm of all these partial loops is a help for judging.

8.7.4c: Family 7.4.7-7.4.14: Reversing Whole Loops.

Reversing Whole Loops shall be judged using the same criteria for

Whole Loops. No line is to be flown between the $\frac{1}{4}$ and $\frac{3}{4}$ loop segments, and the radii of all loop segments must be equal (Fig 39a).

Drawing a line

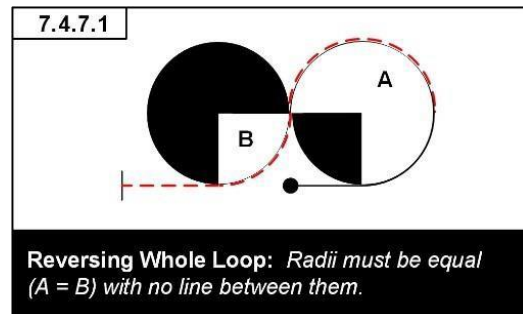

Figure 39a

between the loop segments requires a downgrade of at least two (2) points depending on the length of the line drawn. Rolls placed either before or after the Reversing Whole Loop shall be flown with no line segment between the roll and the loop. Drawing a line requires a downgrade of at least two (2) points depending on the length of the line drawn. Any rolling element flown at the apex (top of loop) or bottom of the loop shall be judged in accordance with the rules for Whole Loops found in paragraph 9.7.4.a.

8.7.5a: Family 7.5.1-7.5.8: Horizontal "S"s.

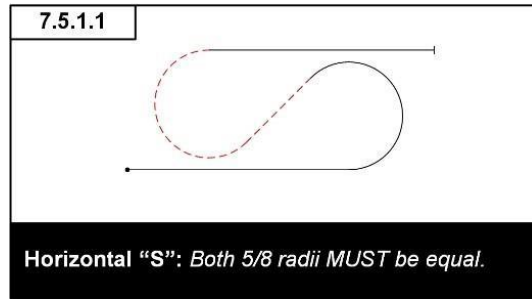

Figure 39b

Horizontal "S"s may be described as two Half Cubans joined together, sharing a common 45 degree line. In these figures, both 5/8ths loops must have the same radii (Fig 39b). When the looping portion of the figure is immediately preceded by (on entry) or

followed by (on exit) a roll or rolls, there must be no visible line between the roll and loop elements. Drawing a line requires a downgrade of at least two (2) points depending on the length of the line drawn. This criterion is not meant to imply that one element (roll or loop) must start before the preceding element is completely finished. A brief hesitation between elements (similar to opposite rolls) should not be downgraded.

Any rolls that are placed on the 45-degree line (between the two 5/8ths looping portions) must be centered on the line, and do not follow or precede the looping portions as described above.

8.7.5b: Family 7.5.9-7.5.10: Vertical “S”s.

These figures are accomplished with two joined half-loops flown in opposite directions (Fig.40). Look for both half-loops to be the same size and perfectly round. The half-loops shall be a continuous looping figure when there is no half roll between the half-loops. When a half roll is performed between the half loops (full roll(s) are not authorized), there is no line

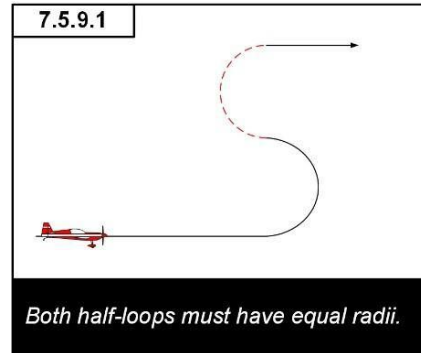

Figure 40

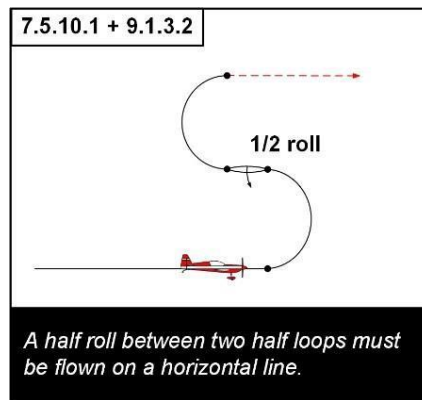

Figure 41

before or after the half roll. However, the half roll is flown on a horizontal line which begins as soon as the first half-loop is finished. As soon as the half roll is finished, the next half-loop must begin immediately (Fig. 41). Adding a line at either of these points is at least a two (2) point deduction, depending on the length of the line.

8.7.6: Not in Use.

8.7.7: Not in Use.

8.7.8a: Family 7.8.1-7.8.8: Horizontal Eights.

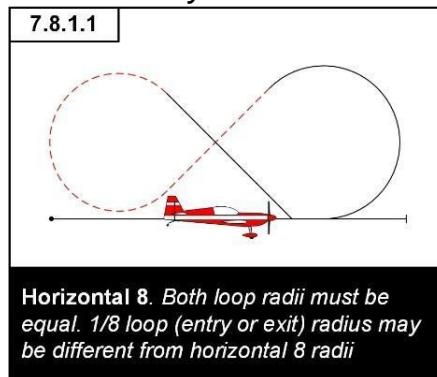

Figure 42

Also referred to as “Cuban Eights,” the 5/8ths and 3/4 loops must have the same radii; lines between the loops must be of equal length (line length criteria applies: Fig 14) and wind corrected to be flown at exactly 45 degrees (Fig. 42). If there are roll elements on the 45 degree line(s), they will be positioned so that the lines before and after the roll are of equal

length. When the 5/8ths loop portion is preceded or followed by a roll element, there must be no visible line between the roll element

and the 5/8ths loop. Inserting a line between the roll element and 5/8ths loop portion requires a minimum downgrade of 2 points. The radius of the 1/8 loop between the 45 degree line and horizontal flight need not equal the radii of the 5/8ths and 3/4 loops of the Horizontal 8.

8.7.8b: Family 7.8.9-7.8.16: Horizontal Super “8”s.

Besides possessing the unique characteristic of containing three 45-degree lines on which rolls may potentially be placed, this family can be thought of as two linked Three-Quarter Loops (Family 7.3).

The radii of the two 3/4 loops must be identical to each other. However, the radii of the two three-quarter (3/4) loops are not required to match the radii of the entry or exit loops. Each of the 45-degree lines may be of different lengths, but any rolls placed on them must be centered. The two 3/4 loops need not occur at the same altitude, nor is there any relationship between the horizontal entry/exit altitude and the altitude limits of the two 3/4 loops (Fig. 43).

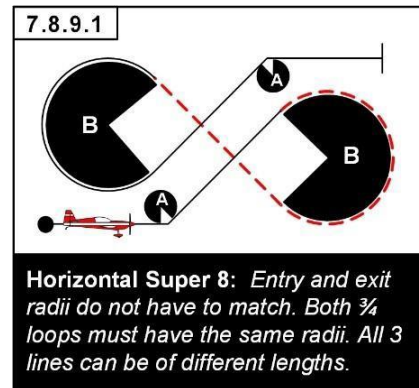

Figure 43

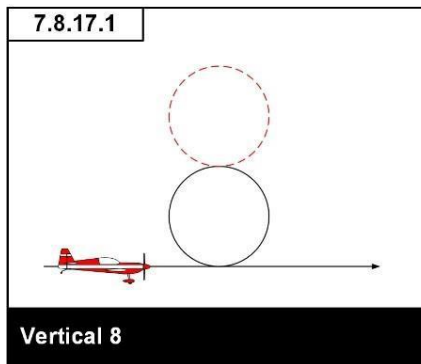

Figure 44

8.7.8c: Family 7.8.17–7.8.22: Vertical “8”s.

These figures are performed by flying two loops, one above the other (Fig. 44).

Sub-family 7.8.17-7.8.20 is composed of two loops, both above or both below the entry altitude. Sub-family 7.8.21 - 7.8.22 is composed of one loop above and one loop below the entry altitude. In either case, the entry and exit altitude must be the same.

These figures may be combined with various types of half rolls. When a half roll is performed between the loops, there is no line before or after the half roll. However, the half roll is flown on a horizontal line that begins as soon as the first loop is finished.

As soon as the half roll is finished, the next loop must begin immediately. Adding a line at either of these points is at least a two (2) point deduction depending on the length of the line. These figures are to be graded using the same criteria as full loops. Additionally, both loops must be of the same size.

Unless there is a half roll between the loops, they must be directly above one another. Here as well, the beginning and the end point of the maneuver will not be in the same vertical plane if a half roll is flown between the loops (Fig. 45). This should not be a reason for downgrade.

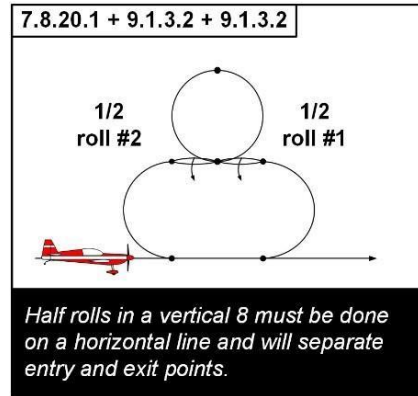

Figure 45

8.8: Family 8: Combination of Lines, Loops, and Rolls.

8.8.1: General Principles.

Family 8 figures are covered in the following sections. Each section provides the maneuver description and the overall judging criteria for the group. Each section also provides, for the most part, the downgrades to be applied for deviations. However, some downgrades in some of the sections are not completely specified and, as such, are described here.

a. The size of a loop or part loop is not a grading criterion.

It will vary according to the flight characteristics of the aircraft. A large loop is not graded any higher or lower than a small loop, but any variation to the radius will downgrade these figures.

b. All radii are to be constant.

Each visible variation in the radii in a loop or part loop is to be downgraded by one (1) point.

c. Where radii of part loops within these figures are required to be the same and they are not, a downgrade of one (1) point shall be applied for each mismatch.

The standard is the first part loop flown within the figure.

d. Roll elements that are to be done on lines must be centered and are to define two equal length line segments either side of the roll element.

Refer to rule 9.2.2 for downgrades.

e. Where a roll element is to be done entering or exiting a part loop there is to be no line shown between the part loop and the roll element.

The downgrade for showing a line in these situations is a minimum of two points. This criterion is not meant to imply that one element (roll or loop) must start before the preceding element is completely finished. A brief hesitation between elements (similar to opposite rolls) shall not be downgraded.

8.8.2 to 8.8.3: *Not in Use.*

8.8.4: *Family 8.4.1-8.4.28: Humpty Bumps and Diagonal Humpty Bumps*

These figures, whether vertical or performed with 45-degree lines, are judged as combination of lines and loops. However, the half loop in the middle of the figure can be of a different radius than the entry or exit radii. (Fig. 46). These half loops must still have a constant radius from the time they depart the vertical or 45-degree line. This requires a change in angular velocity during the half loop.

The lines in these figures may be of different lengths, and therefore the entry and exit altitudes of these figures can be different. Rolls on any of these lines must be centered.

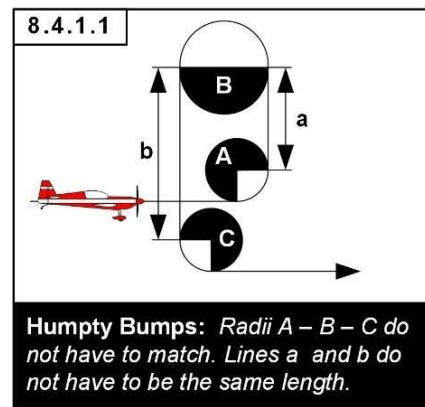

Figure 46

**8.8.5: Family 8.5.1-8.5.24:
Half Cubans and Vertical
5/8ths Loops.**

When the looping portion of the figure is immediately preceded or followed by a roll or rolls, there must be no visible line

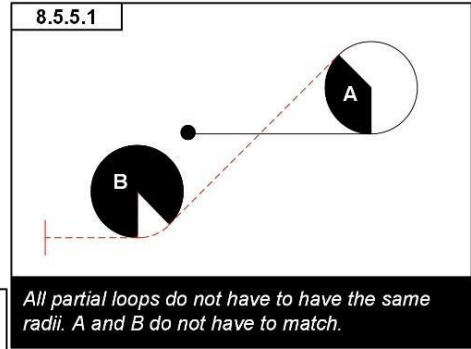

Figure 47

between the roll and loop elements. The rolls on vertical and 45-degree lines must be centered, except for roll(s) following a spin. Angles drawn in the “ARESTI Aerobic Catalogue (Condensed)” (Fig. 47 and 48), are to be flown as

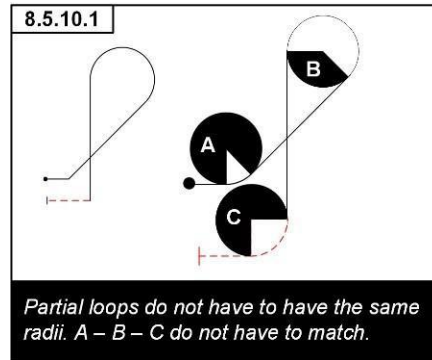

Figure 48

partial loops. In the case of this figure, a 5/8 loop is flown followed by a 45-degree downline with an optional roll and then a 3/8 loop back to upright horizontal flight.

**8.8.6: Family 8.6: “P”
Loops and Reversing
“P” Loops**

When 1/4, 1/2, or 3/4 loops join each other in these sub-families, the radii must be equal and there is no line between the loops. Inserting a line between joined loop segments requires a minimum two (2) point deduction depending on the length of the line (Fig. 49).

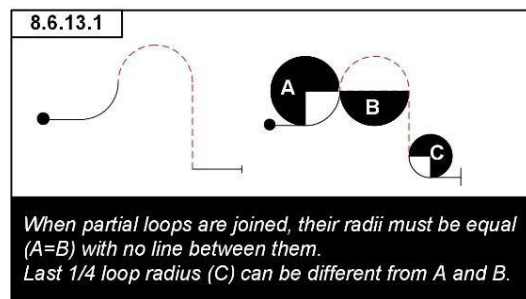

Figure 49

Roll elements on the vertical line must be centered.

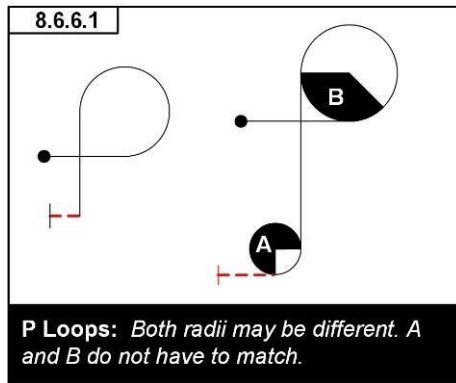

Figure 48a

Roll elements at the apex of the loop must be centered in the loop and flown on the arc of the loop. Flying the roll on a line at the apex of the loop is at least a two (2) point downgrade. If the roll is not centered, it must be downgraded 0.5 points for every five degrees that it is off center.

When a loop portion is preceded or followed by a roll element, there must be no visible line between the roll element and the loop portion. Inserting a line between the roll element and loop portion requires a minimum downgrade of 2 points.

The 1/4 loop to or from horizontal flight shall have a reasonable radius, but need not match the other looping radii (fig.48a).

8.8.7: Family 8.7: 7/8ths Loops.

Sometimes called “Q Loops,” these figures consist of a 7/8ths loop with either a 45 degree entry or exit line. The 1/8th loop to or from the 45 degree line shall have a reasonable radius, but need not match the radius of the 7/8ths loop. (fig.49b)

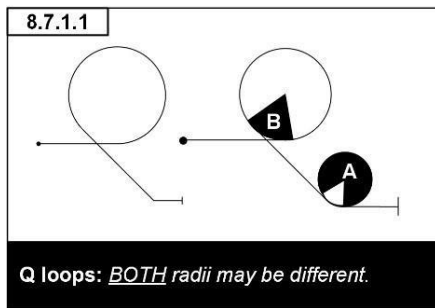

Figure 49b

Roll elements on the 45 degree line must be centered. Roll elements at the apex of the 7/8ths loop must be centered on the loop and flown in the arc of the loop. Flying the roll on a line at the apex of the loop is at least a two (2) point downgrade. If the roll is not centered, it must be downgraded 0.5 points for every five degrees that it is off center.

When the 7/8ths loop is preceded or followed by a roll element, there must be no visible line between the roll element and the loop. Inserting a line between the roll element and 7/8ths loop requires a minimum downgrade of 2 points.

When the 7/8ths loop is preceded or followed by a roll element, there must be no visible line between the roll element and the loop. Inserting a line between the roll element and 7/8ths loop requires a minimum downgrade of 2 points.

Note: for certain types of “Q” Loops in this family, rolls are not allowed at the apex of the 7/8th loop (for example, figures 8.7.x.3 and 8.7.x.4).

8.8.8: Family 8.8: Double Humpty Bumps.

These figures are generally judged using the same criteria as Single Humpty Bumps. (See section 9.8.4.1) The two half-loops are not required to match each other, nor are they required to match either the entry/exit loop radii. As with Single Humpty Bumps, the entry and exit altitudes need not be equal (Fig.49a).

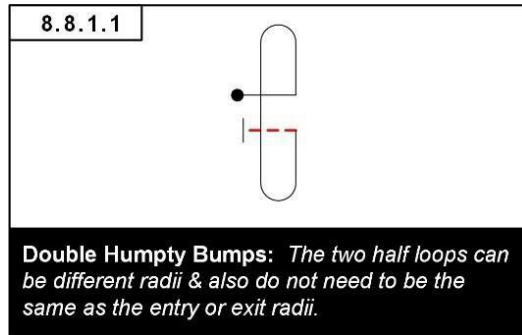

Double Humpty Bumps: The two half loops can be different radii & also do not need to be the same as the entry or exit radii.

Figure 49a

8.8.9: Not in Use.

8.8.10: Family 8.10: Reversing 1 ¼ Loops.

The ¾ and ½ loops in these sub-families must be the same size and are flown as continuous segments with no line between the loops. Inserting a line between joined loop segments requires a minimum two (2) point deduction depending on the length of the line.

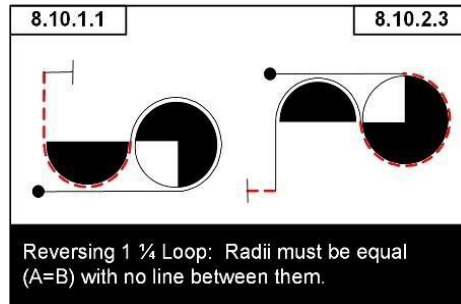

Reversing 1 ¼ Loop: Radii must be equal (A=B) with no line between them.

Figure 48b

Roll elements on the vertical line must be centered.

When the ¾ loop is preceded by a roll element, there must be no visible line between the roll element and the loop portion. Inserting a line between the roll element and loop portion requires a minimum downgrade of 2

points.

The final ¼ loop to horizontal flight shall have a reasonable radius, but need not match the other looping radii (Fig 48b).

8.9: Family 9: Rotational Elements. Rolls (9.1-9.10)

May be performed on horizontal, 45-degree or 90-degree lines, on complete loops, between part-loops, between part-loops and line, and following spin elements. They may be $\frac{1}{4}$, $\frac{1}{2}$, $\frac{3}{4}$, or a full 360 degrees in their rotation, up to two consecutive full rolls. Additionally, rolls may be flown in combination with turns as prescribed in Family 2 (Rolling Turns). In all cases, the same criteria apply: the rate of roll must be constant throughout the roll(s). The aircraft shall continue to project, during the rolling portion, the prescribed plane and direction of flight.

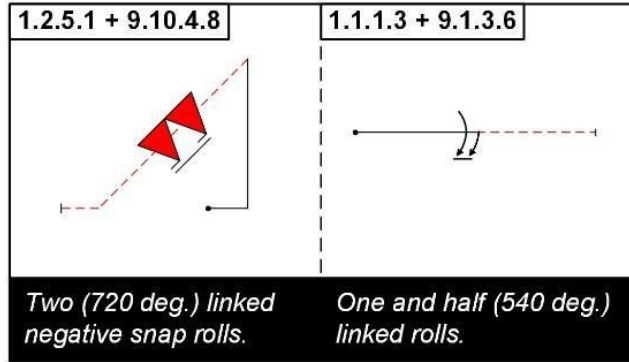

Figure 50

Multiple rolls may be linked, unlinked or opposite:

a: When rolls are in continuous rotation, the tip of the symbols are linked by a small line.

When flying linked rolls there is no pause between them, (Fig.50). Should there be one; the figure shall then be zeroed.

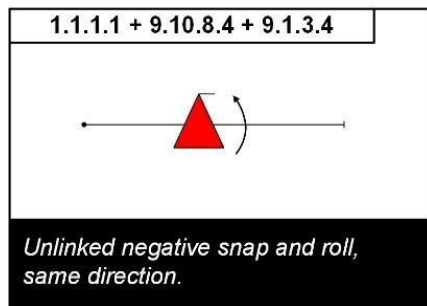

Figure 51

b: Unlinked rolls must be of different types, the two types being defined as follows:

Type I: Aileron rolls (rolls and point rolls)

Type II: Snap rolls (positive and negative) – also referred to as “Flick Rolls”

No line links the symbols, though their tips are drawn pointing in the same direction (i.e. on the same side of the line). Unlinked rolling elements must show a brief but perceptible pause between the elements that comprise the rolling combination. Absence of a perceptible pause between elements of the combination shall be downgraded by 1 point. This downgrade applies if the direction of rotation is required to be the same or opposite. (Fig. 51)

c: Opposite rolls may be either of the same or different type.

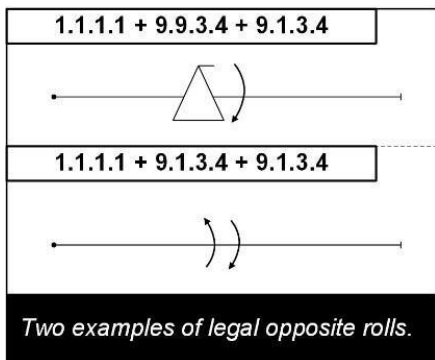

Figure 52

In opposite rolls, the tips of the symbols are drawn on opposite sides of the line, indicating they are to be flown in opposite directions of rotation. The pilot may elect to fly the first roll in either direction, but the second roll must be the opposite direction to the first. Opposite rolls, including those in rolling turns, shall be flown as one continuous maneuver - the brief pause between opposite rotations shall be minimal (Fig. 52). If the two rolls are of the same type,

they must be flown in opposite direction if they are not linked.

d: Either aileron rolls or snap rolls may follow spin elements (Family 9.11 or 9.12).

A spin and a roll combined on the same vertical downline will always be unlinked. They may be flown either in the same or opposite direction, as shown by the position of the tips of the symbols on the ARESTI diagram. The spin will always be the first element with a maximum of two (2) turns. It can be followed by a second rotational element like a roll or a snap roll also limited to a maximum of two (2) turns (Fig. 53).

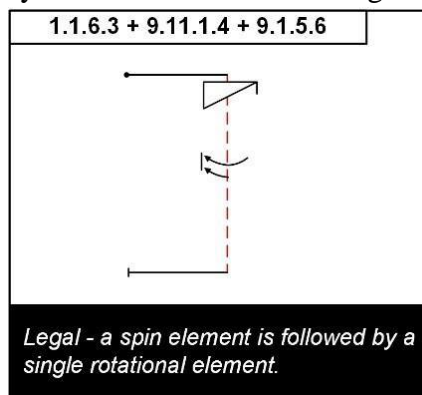
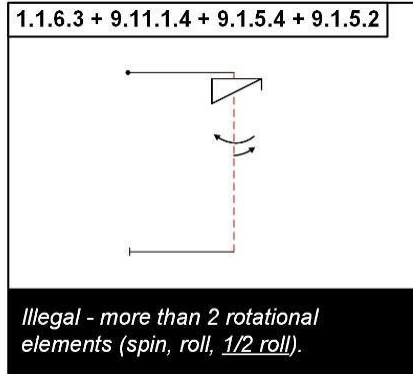

Figure 53



Adding a third rotational element will make the maneuver illegal, i.e. a one turn spin combined with one opposite roll and one opposite half roll (Fig. 54).

Figure 54

9.9.1: Family 9.1: Rolls.

The penalty for varying the rate of roll is one (1) point per variation. Any stoppage in the roll that could result its being considered a point roll would zero (0) the figure.

The finish of the roll must be as crisp and precise as possible. Coming to a slow finish in fact represents a change in the rate of roll and shall be penalized accordingly.

The wing must stop precisely after the desired degree of rotation and not go past the stop point and then return. This is referred to as “bumping the point” and a deduction of 0.5 points per 5 degrees shall be given in this case.

8.9.2: Family 9.2-9.8: Point Rolls.

These rolls are judged on the same criteria as the standard roll, only the aircraft stops rotation during the roll for a pre-stated number of times, i.e. 2, 4, or 8. The rate of the roll and the rhythm of the points must be constant throughout with the aircraft projecting the pre-stated plane and direction of flight.

The pauses will be of identical duration and the degree of rotation between each pause shall be 180 degrees, 90 degrees, or 45 degrees, as depicted by the Aresti diagram. Each visible variation in the duration of the pause segments is downgraded by one (1) point. Errors in degrees of rotation (under/over rotating the points) are downgraded at a half (.5) point per five (5) degrees.

The roll rate of the rolling segments must be constant with each roll segment matching that of the preceding segment. Any visible deviation in roll rate from one segment to the next, or within a segment, is to be downgraded by one (1) point per occurrence.

The duration of the rolling segments as compared to the pause segments need not be equal. Each pause of a point roll must be clearly recognizable in every case. If a pause is not recognizable or is omitted, the figure is graded a zero (0).

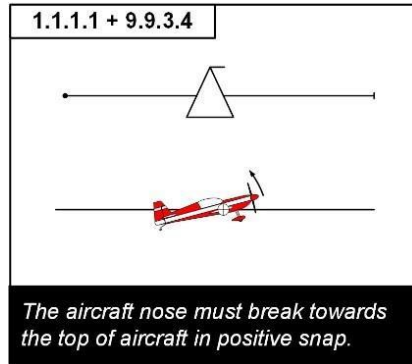

Figure 55

8.9.3: Family 9.9: Snap Rolls (“Flick Rolls”).

Snap rolls may be positive (pitch to the canopy) or negative (pitch to the wheels). All judging criteria are the same for either type of snap. Two essential components of snaps must be observed in order for judges to determine that a snap roll has occurred:

1) Pitch Departure: The aircraft must display a clearly visible change in pitch attitude in the proper direction – towards the canopy in positive snaps; towards the wheels in negative snaps (Fig. 55 & 56).

2) Autorotation: Either immediately following, or simultaneously with the pitch departure, the aircraft must enter autorotation.

Autorotation: State of flight in which the aircraft is rolling while also displaced from straight flight (or radius in loops and part loops) in both the pitch and yaw axes. Autorotation involves an imbalance in lift between left and right wings created by the wing being near, or exceeding, the aircraft’s critical angle of attack while yaw is induced.

Given the high energy nature of the snap, it can be challenging to tell if these two items are occurring simultaneously or sequentially. Therefore, there is no requirement that these two movements start simultaneously. They may occur simultaneously or sequentially in the order presented. The specific requirements and downgrades that apply to snap roll elements are:

- a. The snap must be of the type indicated by the Aresti diagram: Positive or Negative. If the snap is of the incorrect type, the maneuver shall be zeroed. Judges must watch very carefully for this as, due to the speed of the snap, it is possible to miss an incorrect direction of the pitch.
- b. There must be an observable departure in the pitch axis in the required direction of the snap. The movement of the aircraft’s nose

in pitch departing the flight path is a necessary clue to the proper execution of snaprolls. As always, the competitor is given the benefit of the doubt, but if a judge is certain that a proper snap roll has not been executed, the maneuver shall receive a zero (0).

c. Autorotation must be initiated either simultaneously with the pitch departure, or immediately subsequent to it. No downgrade is to be applied if these two motions occur sequentially in the order just stated. Autorotation may be difficult to discern, but there will be a visible yaw displacement to the rotation. Lacking any observable yaw component, the aircraft will be rotating only on its roll axis and not presenting a snap. As always, the pilot receives the benefit of the doubt, but if a judge is certain that autorotation is absent and that a proper snap roll has not been executed, the maneuver shall receive a zero (0).

d. Any rotation / roll observed prior to the required pitch movement is to be downgraded 0.5 points for each 5 degrees of such rotation.

e. In the event that the start of autorotation is delayed somewhat after the required pitch movement has been shown, it is possible that the aircraft will draw a visible line between the pitch and the start of autorotation. If this occurs, the maneuver shall receive a zero (0).

f. Autorotation, once initiated, must be maintained to the prescribed finish point of the snap roll. Exiting autorotation early and completing the snap with ailerons is a common error. In these cases, a downgrade of 0.5 points for each 5 degrees of rotation remaining at the point the autorotation ends shall apply. If the autorotation ends with more than 90 degrees of rotation remaining, the snap roll is to be zeroed.

g. The aircraft's flight path may vary from the prescribed line of flight during the snap due to the pitch and yaw displacement which is characteristic of proper snaps. This variation may be small and difficult to detect. Displacement or the lack thereof, is not a judging criterion. Immediately upon completion of autorotation, the aircraft must be realigned with the prescribed line of flight. This will put the aircraft on a parallel but offset line or arc from that being flown prior to entry to the snap. No penalty is to be applied for the offset or the realignment of the aircraft immediately after autorotation is completed. Lacking that realignment, the aircraft may establish a flight path not parallel to that prior to the snap. Any such misaligned flight path shall be downgraded at 0.5 for each 5 degrees of angular error from the prescribed line of

flight in pitch, roll and yaw. Note: “Line of flight” as used here includes loops and part loops where roll elements are present.

8.9.4: Family 9.11-9.12: Spins.

Spins may be positive (entered from upright flight) or negative (entered from inverted flight). Other than this difference, all judging criteria are the same for either type of spin.

Spin elements may be included in a number of Family 1 and Family 8 figures (where so indicated by the optional spin symbol in the ARESTI catalog). All spins begin from horizontal flight with a defined entry line. This entry line to the spin is to be judged and downgraded as required in the same manner as any other wind corrected

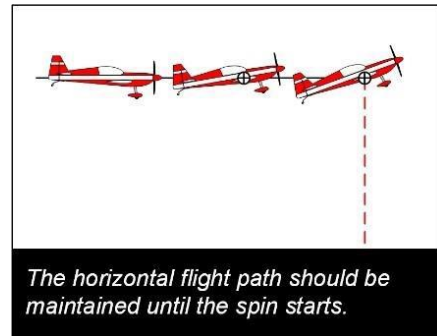

Figure 57

horizontal line. The only exception to judging the entry line is if the spin entry line is also the entry to the sequence. In this instance, the entry line is not judged and judging begins at the spin stall break. It should be noted that the flight path of the spin entry line should remain constant and not be influenced by the change of pitch attitude required to achieve the stall (Fig. 57), i.e., judge the track.

When the aircraft stalls, the nose will fall and at the same time a wing tip will drop in the direction of the spin initiating autorotation. The fall of the nose and the drop of the wing are to occur simultaneously. Failure to achieve this is to be considered a “late entry” and is to be downgraded. After completion of the prescribed number of turns, the aircraft must stop rotating precisely on the prescribed heading and then a wind corrected vertical down line must be shown. If a roll element follows a spin, there shall be a brief, but perceptible pause (similar to unlinked rolls) between the spin and the roll. Because there is no vertical line before the spin, there is no criterion to center a roll element that follows the spin on the vertical down line. No account is to be taken of the pitch attitude of the aircraft during autorotation, as some aircraft spin in a nearly vertical pitch attitude while others may spin in a somewhat flat attitude. Given these varying attitudes some aircraft may require a visible downward movement in order to set the aircraft into position to fly the required vertical downline after completion of autorotation. No downgrade is to be applied for this

Rotation movement in the incorrect direction is to be downgraded at .5 point for each 5 degrees of incorrect rotation.

f. The rotation in a spin must be autorotation which can be difficult to discern.

A clue to making the judgment on "autorotation or not" is that autorotation will have a visible yaw component to the rotation. Absent this yaw component, it is probable that the aircraft is in some kind of an aileron roll. If a judge is certain that no autorotation occurred, a zero (0) is to be given.

g. The spin element must complete precisely at the degree of rotation called for by the ARESTI and not be short or beyond the prescribed end point of the rotation.

Any deviation is to be downgraded 0.5 points per 5 degrees that the aircraft completes the spin short or long of the prescribed stopping point. Note that autorotation must carry to completion. It is common to see a pilot come out of autorotation early and aileron to the finish of the spin. If this occurs a penalty of 0.5 points per 5 degrees is to be applied for the amount of "aileroning" used to complete the required rotation.

h. Upon completion of the prescribed degree of rotation a vertical down line is to be shown.

Omission of this line is to be downgraded one (1) point. Note that roll or snap elements may be called for on this down line after a spin. If they are called for, no centering requirement applies to the placement of these elements on this down line.

SECTION III: GLOSSARY AND DEFINITIONS

- **Advanced:** The fourth of the five categories of aerobatic competition. Advanced competitors fly two programs: a Known program which changes each year, and an Unknown Program.

- ✓ **Aerobatic Airspace**: The airspace in which the aerobatic flight takes place. Must be a minimum of 100 feet from the flight line.
- ✓ **Aileron Roll**: One of two types of rolls as defined by the *Aresti Aerobatic Catalogue*. Aileron rolls include two subtypes: “slow rolls” and “hesitation rolls”.
- ✓ **Airspace Control Score**: Single score added to the end of the score sheet representing the pilot’s ability to optimally place the figures of the sequence.
- ✓ **Angle-of-Attack**: The angle at which the wings of an airplane meet the relative airflow. Can be either positive or negative.
- ✓ **Angle-of-Incidence**: The angle at which the wing is physically mounted to the aircraft’s fuselage.
- ✓ **Aresti Aerobatic Catalogue (Condensed)**: Also referred to as the Aresti System, it is a notation and scoring system developed by José Luis Aresti of Spain in 1961. Each figure is assigned to one of nine families and given a unique catalog number and difficulty factor (“K”). With the exception of the Four Minute Freestyle Program, only figures listed in the *Aresti System (Condensed)* are legal for IMAC competition.
- ✓ **Attitude**: The aircraft’s pitch, yaw, and roll position in relation to the true horizon.
- ✓ **Autorotation**: State of flight in which the aircraft is rolling while also displaced from straight flight (or radius in loops and part loops) in both the pitch and yaw axes. Autorotation involves an imbalance in lift between left and right wings created by the wing being near, or exceeding, the aircraft’s critical angle of attack while yaw is induced
- ✓ **Avalanche**: Common name given to a full loop with a Family 9 snap roll maneuver centered at the 180 degree point of the loop.
- ✓ **Basic**: The entry level category of IMAC competition. Basic competitors fly one program, a Known program which changes each year, there is no Unknown program in Basic.
- ✓ **Base Figure**: Any figure found in Families 1 through 8 of the *Aresti Aerobatic Catalogue*.
- ✓ **Bow Tie**: Any of the Sub-Family 1.3.1.x to 1.3.8.x figures.
- ✓ **Break Penalty**: A fixed numerical penalty added to a sequence in which there was a Corrective Maneuver or a Break in Sequence.
- ✓ **Break in Sequence**: A term used to describe a complete departure / interruption of the proscribed program (actions exceeding those of a Corrective Maneuver).
- ✓ **Catalogue Number**: A way of uniquely identifying each figure in the *Aresti Aerobatic Catalogue*. The number is in the form of four numerical groups separated by periods and takes the form:
FAMILY.SUBFAMILY.ROW.COLUMN.
- ✓ **Competition Class**: Any of the five competitive skill levels: Basic, Sportsman, Intermediate, Advanced, and Unlimited.
- ✓ **Center of Gravity Track (CGT)**: An imaginary line drawn by the aircraft’s CG during flight (flight path).

- ✓ **Complementary Figure**: Any rotational element from Family 9 of the *Aresti Aerobatic Catalogue*. Complementary figures are always combined with a base figure, i.e., they never stand alone.
- ✓ **Contest, Sanctioned**: An aerobatic competition sanctioned by AMA, and conducted in accordance with current AMA Scale Aerobatics rules.
- ✓ **Corrective Maneuver**: A figure (1/2 roll, and / or up to 270 degree turn) added to the sequence to reposition the aircraft in its proper orientation to continue the sequence.
- ✓ **Deadline**: A line established by the AMA to separate the Aerobatic Airspace from the pilots and judges from the flight performances.
- ✓ **Double Humpty Bump**: Any of the figures from Sub-Families 8.8.1.x – 8.8.8.x consisting of two regular humpty bumps, one going up and the other going down, sharing a common vertical line.
- ✓ **Family**: A group of related figures from the *Aresti Aerobatic Catalogue*. There are eight Families (1 - 8, with Family 4 currently not used) of base figures and one Family (9) of complementary figures.
- ✓ **Figure**: Each individual component of an aerobatic sequence, which may contain one or more maneuvers in combination. Figures always start and end with a horizontal line, either upright or inverted.
- ✓ **Flick Roll**: Another name for a snap roll.
- ✓ **Flight path**: The trajectory of the aircraft's center of gravity when compared with the true horizon. In competition, an aircraft's flight path must be parallel to the X or Y axes to avoid deduction.
- ✓ **Flimsies**: Drawings showing the continuity of figures in an aerobatic sequence, i.e., Forms B and C.
- ✓ **Form A**: The contestant's score sheet which includes for each figure: the *Aresti Aerobatic Catalogue* symbol, number, and K- Factor for each maneuver comprising the figure, as well as the total K-Factor for each figure and the total K-Factor for the entire sequence.
- ✓ **Form B**: The sequence drawing showing figures as flown with the wind direction from the Judges' right to left.
- ✓ **Form C**: The sequence drawing showing figures as flown with the wind direction from the Judges' left to right.
- ✓ **Four Minute Freestyle**: A separate contest program that can be optionally scheduled as the final event of a contest based on available time and willing competitors. Freestyle is open to any pilot who competed in one of the five IMAC precision classes and has its own winners and separate trophies. The freestyle is unique in that the selection of figures for this program need not be made with reference to the *Aresti System (Condensed)*. All rules governing the Four Minute freestyle can be found in Scale Aerobatics Competition Regulations General Principles, Section 17.
- ✓ **Goldfish**: Common name given to any of the three-quarter loop figures from Sub-Families 7.3.1.x to 7.3.4.x
- ✓ **Grade**: The number assigned by each Judge to each figure in a sequence indicating their judgment of the quality of the figure as flown. Grades may

range from 10 (perfect) to zero in one half point increments. Also referred to as a “mark.”

- **Half Cuban 8**: Common name given to a Family 8 figure beginning with a 5/8th loop followed by a 45° line. (See also, “Reverse Cuban 8”).
- **Hammerhead**: Any of the Family 5 figures. Also called a “stall turn”.
- **Heading**: Compass direction in which an aircraft is pointed. In a competition, the aircraft’s heading may not always be parallel to the X or Y axes, as heading will change with wind correction to maintain a Flight Path that is parallel to the X or Y axes.
- **Hesitation Roll**: A subtype of aileron roll where rotation is momentarily stopped a set number of times during the roll. Hesitation rolls may be broken into 2, 4, and 8 equal segments and may have a total rotation of 90 degrees to 720 degrees. Also referred to as “point rolls”.
- **Horizontal 8**: Common name given to any of the figures from sub-families 7.8.1.x to 7.8.8.x. Also called a “lay-down eight.”
- **Horizontal Line**: The flight path of an aircraft when flown on a constant heading at a constant altitude.
- **Horizontal S**: Two consecutively flown 5/8 loops from Sub-Family 7.5.1.x – 7.5.8.x
- **Humpty Bump**: Common name given to any of the figures from sub-families 8.4.1.x to 8.4.28.x. Also simply called a “humpty”.
- **IMAC**: International Miniature Aerobatics Club: A Special Interest Group (SIG) of the Academy of Model Aeronautics promoting and supporting scale aerobatics competition.
- **Immelmann**: Common name given to a Family 7 figure consisting of a half-loop up.
- **Inside**: Same as “positive”. Used primarily to describe positive looping figures and snap rolls.
- **Interior Line**: Any straight line segment, other than the horizontal entry and exit lines, which go to make up a basic Aresti figure.
- **Intermediate**: The third of the five categories of aerobatic competition. Intermediate competitors fly two programs: a Known program which changes each year, and an Unknown Program.
- **K-Factor**: The difficulty factor for each maneuver taken from the *Aresti Aerobatic Catalogue*, which, when added together, becomes the “K” for a figure.
- **Known Program**: A different sequence of figures for each category, Sportsman through Unlimited, published at the beginning of each contest year.
- **Lay-down 8**: Same as “Horizontal 8”.
- **Maneuver**: Any one of the basic aerobatic movements which may be combined to make a figure (e.g., a half-loop plus a half slow roll are two maneuvers combined to make the Immelmann figure).
- **Mark**: Term which can be used synonymously with “grade” or “score.”

- ✓ **Negative**: A condition of flight when the aircraft endures the force of gravity acting opposite of normal, i.e., in a direction from “foot” to “head.” Negative flight does not imply any particular attitude of the aircraft relative to the ground and is depicted in Aresti diagrams with a dashed line.
- ✓ **Negative Snap Roll**: Also called an “outside snap”, this figure incurs negative G-forces and the wing is stalled negatively.
- ✓ **Outside**: Same as “negative”. Used primarily to describe negative looping figures and snap rolls.
- ✓ **Point Roll**: See “Hesitation Roll”.
- ✓ **Positive**: A condition of flight when the aircraft endures the force of gravity acting normally, i.e., in a direction from “head” to “foot.” Positive flight does not imply any particular attitude of the aircraft relative to the ground and is depicted in Aresti diagrams with a solid line.
- ✓ **Positive Snap Roll**: Also called an “inside snap”, this figure incurs positive G-forces and the wing is stalled positively.
- ✓ **Reverse Half Cuban 8**: A “Half Cuban 8” flown with the 45° line first followed by the 5/8th loop.
- ✓ **Reversing P-Loop**: Any of the figures from Sub-Families 8.6.9.x – 8.6.16.x where the direction of the three quarter loop is reversed after either the first quarter or the first half loop.
- ✓ **Reversing Whole Loop**: Any of the figures from Sub-Families 7.4.7.x – 7.4.14.x, consisting of a full loop in which either the first or last quarter changes direction.
- ✓ **Rolling Turn**: Any of the figures from Family 2 which combine aileron rolls with turning flight. Also called a “Rolling Circle.”
- ✓ **Sequence**: A grouping of aerobatic figures which constitutes one program.
- ✓ **Shall**: As used in this rule book, “shall” (or “must”) indicates the referenced action is mandatory, not optional.
- ✓ **Shark’s Tooth**: Common name for any of the figures from subfamilies 1.2.1.x to 1.2.16.x
- ✓ **Should**: As used in this rule book, “should” indicates the referenced action is desirable, but not mandatory, and there is no associated penalty for not performing the referenced action.
- ✓ **Slow Roll**: A subtype of aileron roll characterized by continuous rotation ranging from 90 degrees to 720 degrees. “Slow” does not imply a particular rate of rotation which may, in fact, be very fast.
- ✓ **Snap Roll**: One of two types of rolls as defined by the *Aresti Aerobatic Catalogue*. Snap rolls may either be “positive” or “negative”. Also called “Flick Rolls.”
- ✓ **Spin**: Any of the spin elements from Family 9.11.x or 9.12.x combined with any of the base figures from Family 1 or Family 8 which contain vertical lines capable of supporting spin elements.
- ✓ **Split-S**: Common name given to a Family 7 figure consisting of a half-loop down.

- ✓ **Sportsman**: The second of the five categories of aerobatic competition. Sportsman competitors fly two programs: a Known program which changes each year and an Unknown program.
- ✓ **Stall**: In flight condition where an increased angle of attack, reduction in airspeed, or combination of both results in the primary lifting surface no longer producing sufficient lift to sustain flight. Stalls may occur at any speed and are not directly correlated to ground speed.
- ✓ **Stall Turn**: Another name for a hammerhead.
- ✓ **Tail Slide**: Any of the Family 6 figures.
- ✓ **Teardrop**: Common name for the vertical 5/8 loops, Family 8.5.9.x thru 8.5.24.x
- ✓ **Track**: The same as flight path.
- ✓ **Unknown Program**: A sequence of figures provided by IMAC to the Contest Director or Unknown Manager for the Sportsman through Unlimited categories. Unknown programs may not be practiced by the competitors prior to being flown.
- ✓ **Unlimited**: The highest level of the five categories of aerobatic competition. Unlimited competitors fly two programs: a Known program which changes each year, and an Unknown Program.
- ✓ **Vertical 8**: Common name given to any of the figures from sub-families 7.8.17.x to 7.8.22.x.
- ✓ **Vertical S**: Common name given to any of the figures from sub-families 7.5.9.x to 7.5.10.x.
- ✓ **Warm-up Flight**: A competition sequence (Known, or Unknown) flown by a noncompeting pilot to allow the judges to "warm-up" their evaluation skills before the first "real" competitor flies. Normally, warm-up flights are only flown at Championship contests, but may be employed at any contest at the CD's discretion.
- ✓ **Wind Correction**: Adjusting the aircraft's heading in pitch and yaw to counter the effects of wind in so as to maintain a true flight path.
- ✓ **X-Axis**: The main axis of flight, parallel to the flight line.
- ✓ **Y-Axis**: Perpendicular to the X-Axis (cross box).